



The complete  
office collection.  
Designed  
for contemporary  
working spaces.

**Gallotti&Radice**

“L'architettura è, e resta, un meraviglioso processo di sintesi  
in cui sono coinvolte migliaia di componenti umane.”

*Alvar Aalto*

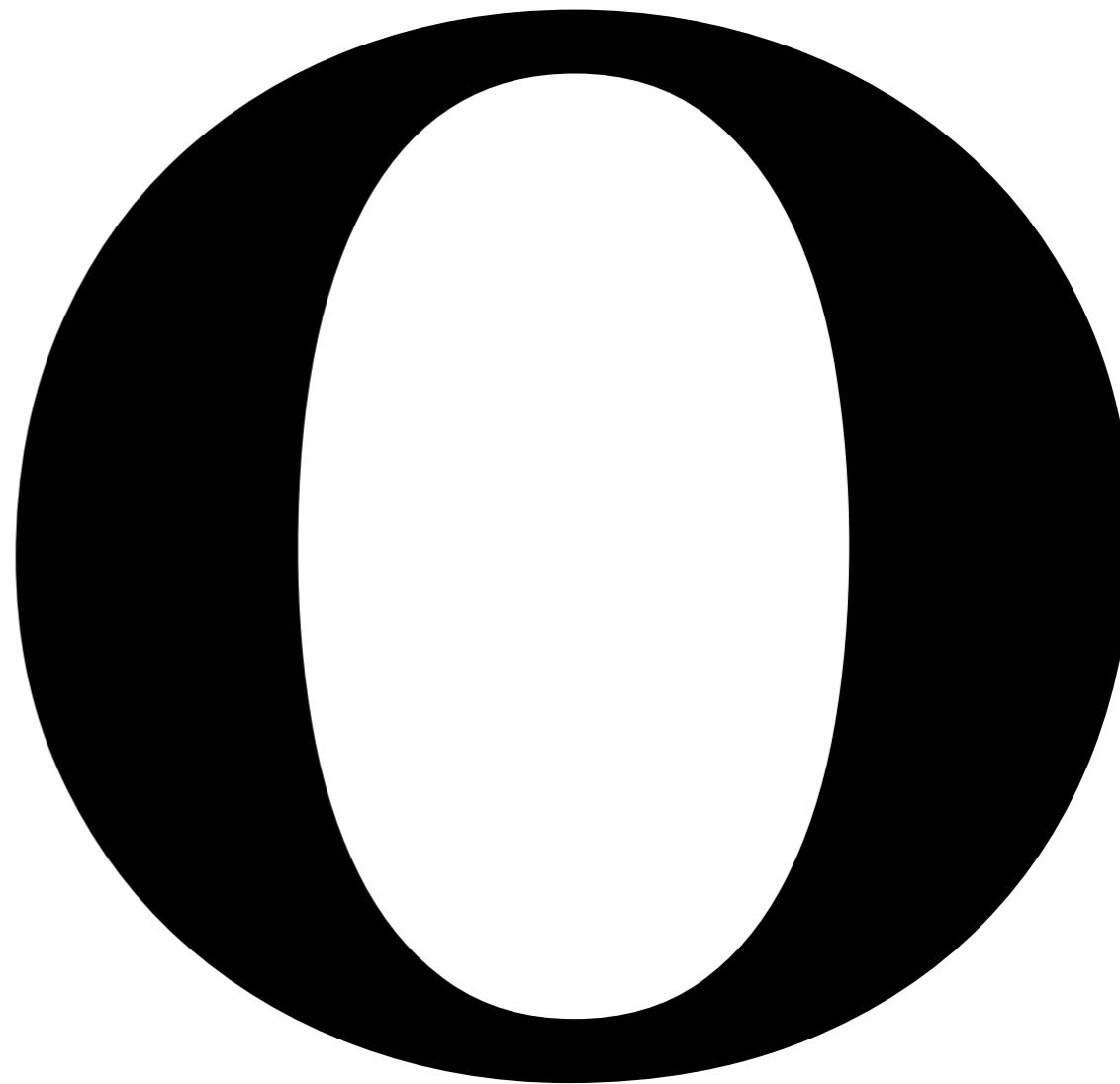
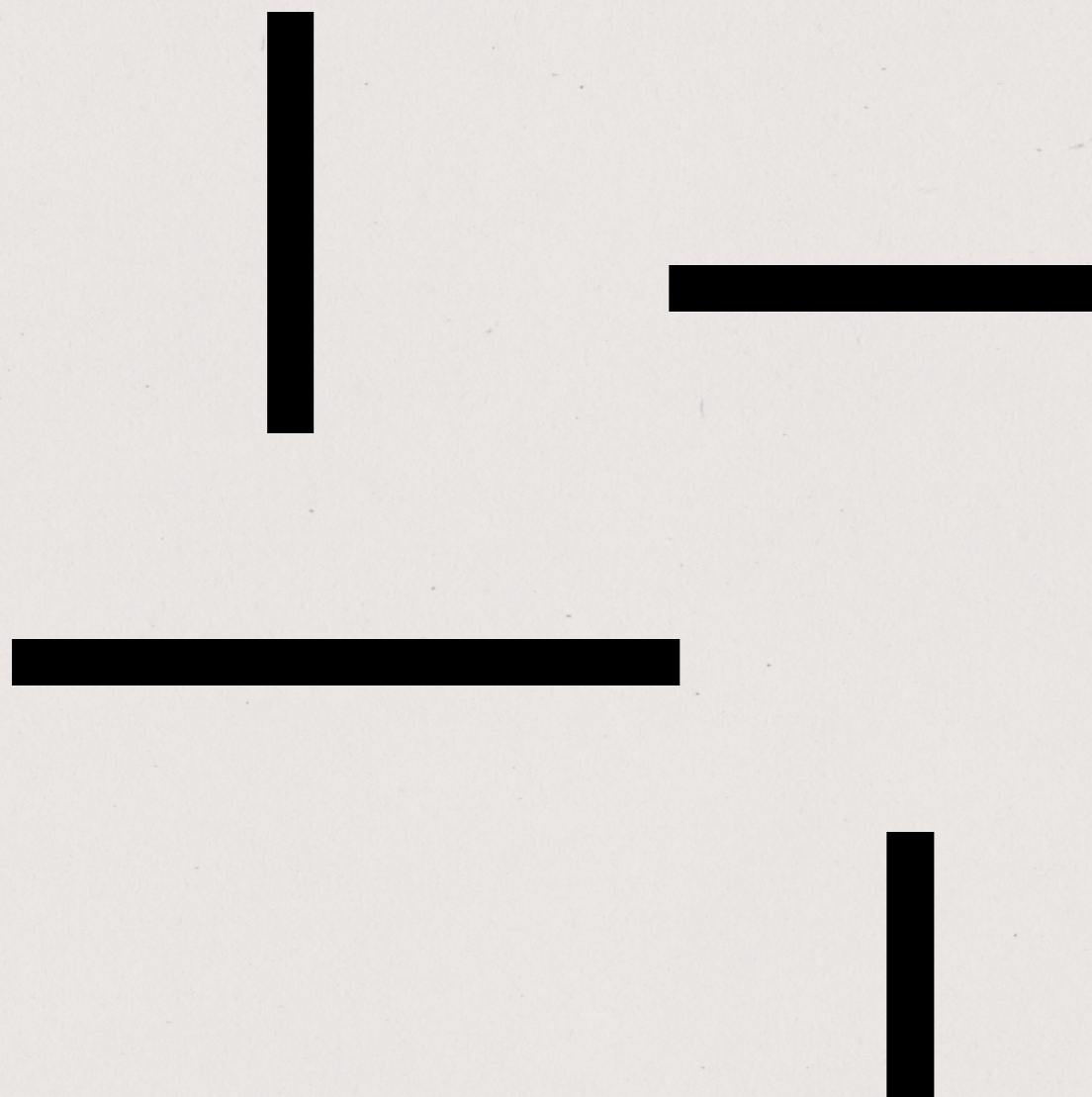

**Office  
Collection**

Fino a non molti anni fa, ogni pezzo di arredo in un ufficio aveva una sua precisa funzione e il lavoro era scandito da ritmi e tempi regolari e ripetitivi. Sulle scrivanie erano appoggiate le macchine da scrivere sostituite poi dai computer e da ingombranti monitor. I contenitori e gli armadi erano pieni di carta e faldoni. I tavoli riunioni erano gli unici elementi "inabitati" e mettevano di conseguenza un po' di soggezione. Oggi che l'hardware sta nella tasca di una giacca e il software segue di conseguenza, che il lavoro è diventato fluido senza rigide costrizioni di orari, che le riunioni sono sempre più frequenti e sempre più "operative". Quali potrebbero essere i requisiti individuabili negli elementi di arredo dello spazio di lavoro? Probabilmente la loro funzione primaria deve essere quella di armonizzare gli spazi del lavoro con la vita delle persone. In questo catalogo presentiamo una collezione dedicata all'ambiente ufficio pensata in questo senso.

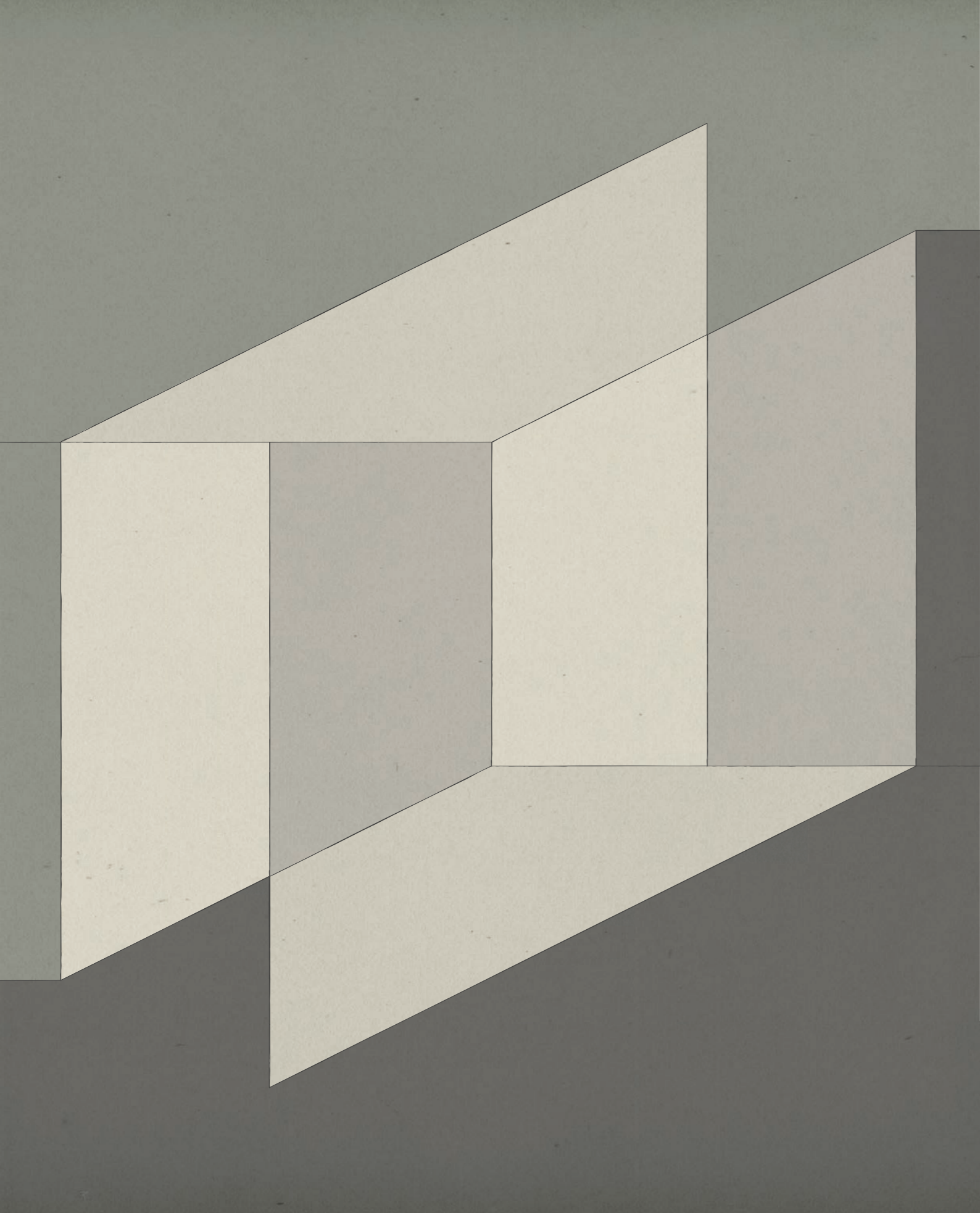

Not so long ago, each piece of furniture in an office had its own specific function and the work was remarked by regular and recurring times. On desks, were typewriters, then replaced by computers and bulky monitors. Cabinets and closets were full of paper and boxes. Meeting tables were the only empty elements and, consequently, they instilled apprehension. Today, technology and software stay in the pocket of a jacket, work has become fluid without strict constrictions in time and meetings are more and more frequent and efficient. Therefore, what could be the requirements of the furnishing elements of the office? Probably, their primary function has to be that of harmonizing workplaces with people's lives. Following this idea, in this catalogue we introduce you to a complete collection, dedicated to office environments.

# 1

**Sistemi e Scrivanie/  
Systems and Desks/  
Systèmes et Bureaux/  
Möbelsysteme  
und Schreibtische**

48 Air Cable  
10 Air Desk 1  
20 Air Desk 1 Up  
30 Air Desk  
36 Air Desk Console  
44 Air Desk Hall  
38 Air Desk Modesty  
34 Air Desk W  
48 Air Pad  
48 Air Tower  
72 Koy Cable  
72 Koy Screen  
66 Koy System  
72 Koy Tower  
92 Milano 1  
92 Milano  
74 President Dattilo  
74 President Scrivania  
78 President Senior/President Junior  
80 Quadra  
84 Smart  
88 Smart Hall  
50 WGS  
64 WGS Accessory Bar  
54 WGS Double  
62 WGS Glove  
58 WGS Plus  
64 WGS Screen  
64 WGS Screen Tray  
62 WGS Shelf  
62 WGS Tolomeo

# 2

**Cassettiere e Contenitori/  
Drawer units and Storage units/  
Bloc tiroirs et Meubles/  
Rollcontainer  
und Möbelcontainer**

98 Air Drawer  
126 Air Lock  
126 Air Stationery  
110 Air Unit  
118 Air Up  
124 Air Up Shelf  
100 Air Wheel  
126 Cover Cable Plate 2  
102 Movie Cassettiera  
104 Movie Metal  
128 Movie W 11  
130 Pandora  
108 President Cassettiera  
106 Techna  
134 Tot

# 3

**Librerie e Boiserie/  
Shelving systems and Boiserie/  
Bibliothèques et Boiserie/  
Regale und Boiserie**

148 Dipsy  
144 Drizzle  
138 Elle Plus 10  
150 Tortona

# 4

**Sedute e complementi/  
Seatings and accessories/  
Sièges et compléments/  
Sitzelemente und Einzelobjekte**

160 0414  
164 Bolle  
158 First  
156 Jackie  
154 OFX 09  
166 Tic Tac  
162 WGS Stool

# 5

**Tavoli riunione/  
Conference tables/  
Tables de conférence/  
Konferenztische**

214 Adam  
182 Air Table  
166 Akim  
206 Big Basic  
184 Carlomagno  
172 Dolm  
198 Eros  
212 Ever  
178 Koy  
188 Lord  
195 Raj  
204 Ra Fx  
208 Smart  
192 Still  
216 Supercalif...  
202 Upside 14  
204 Upside  
210 Yan

# 6

**Accessori ufficio/  
Office Accessories/  
Accessoires pour le bureau/  
Accessoires für Büro**

226 Cover Cable Plate 1, 2, 3  
228 Cable Tube  
230 Glass Pad  
230 Mouse Pad  
228 Movie Tower  
230 Sottomano  
228 Snake

# 7

**Finiture/  
Finishes/  
Finitions/  
Ausführungen**

238 Eco leather  
239 Fabrics  
238 Felt WGS  
234 Glass  
235 Glass Pandora  
238 Leather / Leather Sottomano  
236 Metal  
238 Suede  
238 Velvet  
237 Wood  
237 Wood Layer

# **Sistemi e Scrivanie/ Systems and Desks/ Systèmes et Bureaux/ Möbelsysteme und Schreibtische**

10	Air Desk 1
20	Air Desk 1 Up
30	Air Desk
34	Air Desk W
36	Air Desk Console
38	Air Desk Modesty
44	Air Desk Hall
48	Air Cable
48	Air Tower
48	Air Pad
50	WGS
54	WGS Double
58	WGS Plus
62	WGS Glove
62	WGS Tolomeo
62	WGS Shelf
64	WGS Accessory Bar
64	WGS Screen
64	WGS Screen Tray
66	Koy System
72	Koy Cable
72	Koy Tower
72	Koy Screen
74	President Scrivania
74	President Dattilo
78	President Senior/President Junior
80	Quadra
84	Smart
88	Smart Hall
92	Milano
92	Milano 1

# Air

## Air Desk1

Scrivania in appoggio su sistema Air Unit in cristallo trasparente o "grigio Italia" temperato 12 mm. Disponibile con piano retroverniciato nei colori del campionario nella versione brillante o satinata. A richiesta piano in cristallo laminato effetto pelle. Parti metalliche in acciaio inox lucido, satinato oppure alluminio anodizzato, laccato bianco o nero goffrato. Su richiesta alluminio spazzolato a mano nei colori nero o titanio. Per consentire il passaggio dei cavi è possibile richiedere una foratura nel piano. Distanza minima dal bordo: 10 cm.

Desk with one side resting on Air Unit system in 12 mm transparent or smoked "grigio Italia" tempered glass. Available also with painted glass top as per samples in the bright or satin version. Leather effect laminated glass top, on request. Bright or satin stainless steel, anodised aluminium or embossed white or black lacquered metal parts. Hand brushed aluminium in the colours black or titanium grey, on request. For a proper cable management, a hole on the top can be arranged upon request. Minimum distance from the edge: 10 cm.

Bureau avec un côté posé sur Air Unit système en verre transparent ou "grigio Italia" fumé trempé de 12 mms d'épaisseur. Disponible aussi avec plateau en verre verni dans les coloris de nos échantillons dans la version brillante ou satinée. Sur demande plateau en verre revêtu effet cuir. Parties métalliques en acier inox brillant, satiné ou en aluminium anodisé, laqué blanc ou noir gaufré. Sur demande aluminium brossé à la main dans les coloris noir ou gris titane. Pour permettre le passage des câbles un trou peut être réalisé dans le plateau. Distance minimum du bord: 10 cm.

Schreibtischkombination aufgesetzt auf Air Unit Element: Glas vorgespannt klar oder Rauchglas "grigio Italia" 12 mm. Glas lieferbar auch lackiert nach Musterkarte. Lackierung jeweils hochglanz oder matt satiniert. Auf Wunsch Glasplatte mit Leder-Effekt umkleidet. Metallteile Edelstahl (Inox) poliert, gebürstet oder eloxiertes Aluminium oder weiss oder schwarz strukturlackiert. Lieferbar auch Aluminium handgebürstet in den Farben schwarz oder titan-grau. Kabel können durch eine zu bestellende Bohrung in der Platte geführt werden. Mindestabstand von der Kante: 10 cm.

> **Composizione Air Unit da 365x51x60h cm** rivestita in cristallo retroverniciato grigio beige satinato. Scrivania in appoggio in cristallo trasparente extralight da 200x90x74h cm e parti metalliche in acciaio inox lucido. Sedia OFX 09 h85 cm in pelle scamosciata Sand 06. Specchio Zeiss Mirror 104x6x92h cm con cornice laccata effetto tessuto color castagna.

**Air Unit composition 365x51x60h cm** covered by satin taupe painted glass. Extralight transparent glass desk with one side resting 200x90x74h cm and bright stainless steel metal parts. Chair OFX 09 h85 cm in suede Sand 06. Zeiss mirror 104x6x92h cm with chestnut with "fabric" touch effect lacquered frame.

**Composition Air Unit 365x51x60h cm** recouverte de verre verni taupe satiné. Bureau avec un côté posé, en verre transparent extralight de 200x90x74h cm et parties métalliques en acier inox brillant. Chaise OFX 09 h85 cm en suédine Sand 06. Miroir Zeiss Mirror 104x6x92h cm avec cadre laqué châtaigne en effet tissu.

**Komposition Air Unit 365x51x60h cm** mit beige-grau matt satiniertem Glas umkleidet. Schreibtisch aufgesetzt aus Glas klar Extralight von 200x90x74h cm und Metallteile Edelstahl (Inox) poliert. Stuhl OFX 09 h85 cm Wildleder Sand 06. Spiegel Zeiss Mirror 104x6x92h cm mit Rahmen kastanienbraun mit Stoff-Effekt lackiert.







				Cm (L x P x H)	Inches (W x D x H)
La scrivania Air Desk 1 si posiziona sui moduli contenitori Air Unit, versione a spalla portante 60h cm.	The Air Desk 1 shall rest on Air Unit modules, freestanding version with 60h cm sides.	Le bureau Air Desk 1 se pose sur les meubles Air Unit, version sur pieds par spalles portantes 60h cm.	Der Schreibtisch Air Desk 1 soll auf Air Unit-Möbel, freistehende Komposition mit Seitenwangen 60h cm, gestellt werden.	120 x 80 x 74	47 $\frac{1}{4}$ " x 31 $\frac{1}{2}$ " x 29 $\frac{1}{4}$ "
				140 x 80 x 74	55 $\frac{1}{4}$ " x 31 $\frac{1}{2}$ " x 29 $\frac{1}{4}$ "
				160 x 80 x 74	63" x 31 $\frac{1}{2}$ " x 29 $\frac{1}{4}$ "
				180 x 90 x 74	71" x 35 $\frac{1}{2}$ " x 29 $\frac{1}{4}$ "
				200 x 90 x 74	78 $\frac{3}{4}$ " x 35 $\frac{1}{2}$ " x 29 $\frac{1}{4}$ "
				120 x 120 x 74	47 $\frac{1}{4}$ " x 47 $\frac{1}{4}$ " x 29 $\frac{1}{4}$ "
				140 x 120 x 74	55 $\frac{1}{4}$ " x 47 $\frac{1}{4}$ " x 29 $\frac{1}{4}$ "
				160 x 120 x 74	63" x 47 $\frac{1}{4}$ " x 29 $\frac{1}{4}$ "
180 x 120 x 74	71" x 47 $\frac{1}{4}$ " x 29 $\frac{1}{4}$ "				
200 x 120 x 74	78 $\frac{3}{4}$ " x 47 $\frac{1}{4}$ " x 29 $\frac{1}{4}$ "				

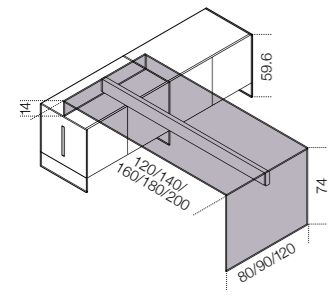

				Cm (L x P x H)	Inches (W x D x H)
La scrivania Air Desk 1 si posiziona sui moduli contenitori Air Unit, nella versione pensile.	The Air Desk 1 shall rest on Air Unit modules, suspended version.	Le bureau Air Desk 1 se pose sur les meubles Air Unit, version murale.	Der Schreibtisch Air Desk 1 soll auf Air Unit-Möbel, Hänge-Komposition, gestellt werden.	120 x 80 x 74	47 $\frac{1}{4}$ " x 31 $\frac{1}{2}$ " x 29 $\frac{1}{4}$ "
				140 x 80 x 74	55 $\frac{1}{4}$ " x 31 $\frac{1}{2}$ " x 29 $\frac{1}{4}$ "
				160 x 80 x 74	63" x 31 $\frac{1}{2}$ " x 29 $\frac{1}{4}$ "
				180 x 90 x 74	71" x 35 $\frac{1}{2}$ " x 29 $\frac{1}{4}$ "
				200 x 90 x 74	78 $\frac{3}{4}$ " x 35 $\frac{1}{2}$ " x 29 $\frac{1}{4}$ "
				120 x 120 x 74	47 $\frac{1}{4}$ " x 47 $\frac{1}{4}$ " x 29 $\frac{1}{4}$ "
				140 x 120 x 74	55 $\frac{1}{4}$ " x 47 $\frac{1}{4}$ " x 29 $\frac{1}{4}$ "
				160 x 120 x 74	63" x 47 $\frac{1}{4}$ " x 29 $\frac{1}{4}$ "
180 x 120 x 74	71" x 47 $\frac{1}{4}$ " x 29 $\frac{1}{4}$ "				
200 x 120 x 74	78 $\frac{3}{4}$ " x 47 $\frac{1}{4}$ " x 29 $\frac{1}{4}$ "				

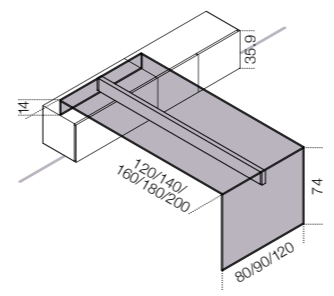

				Cm (L x P x H)	Inches (W x D x H)
La scrivania Air Desk 1 con profondità 47 cm si posiziona sul mobile Air Unit nella modalità illustrata nel disegno.	The Air Desk 1 47 cm deep shall rest on Air Unit container as per drawing.	Le bureau Air Desk 1 prof. 47 cm se pose sur le meuble Air Unit selon le dessin.	Der Schreibtisch Air Desk 1 (Tiefe 47 cm) soll auf Air Unit Element wie die Skizze gestellt werden.	120 x 47 x 74	47 $\frac{1}{4}$ " x 18 $\frac{3}{4}$ " x 29 $\frac{1}{4}$ "
				140 x 47 x 74	55 $\frac{1}{4}$ " x 18 $\frac{3}{4}$ " x 29 $\frac{1}{4}$ "
				160 x 47 x 74	63" x 18 $\frac{3}{4}$ " x 29 $\frac{1}{4}$ "
				180 x 47 x 74	71" x 18 $\frac{3}{4}$ " x 29 $\frac{1}{4}$ "

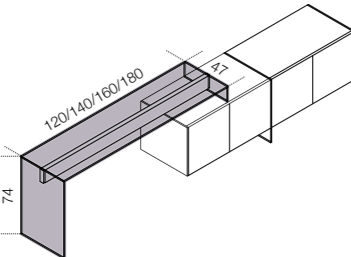
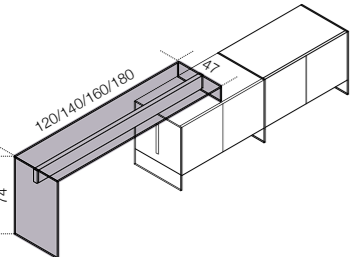

				Cm (L x P x H)	Inches (W x D x H)
Moduli contenitori Air Unit h 35.9 cm per Air Desk 1.	Air Unit modules h 35.9 cm for Air Desk 1.	Meubles Air Unit h 35.9 cm pour Air Desk 1.	Air Unit-Möbel h 35.9 cm für Air Desk 1.	90 x 34.1 x 35.9	35 $\frac{1}{2}$ " x 20 $\frac{1}{4}$ " x 14"
				120 x 34.1 x 35.9	47 $\frac{1}{4}$ " x 20 $\frac{1}{4}$ " x 14"

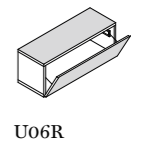
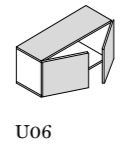
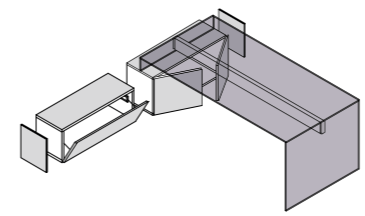

				Cm (L x P x H)	Inches (W x D x H)
Moduli contenitori Air Unit h 45.1 cm per Air Desk 1.	Air Unit modules h 45.1 cm for Air Desk 1.	Meubles Air Unit h 45.1 cm pour Air Desk 1.	Air Unit-Möbel h 45.1 cm für Air Desk 1.	90 x 51 x 45.1	35 $\frac{1}{2}$ " x 20 $\frac{1}{4}$ " x 18"
				120 x 51 x 45.1	47 $\frac{1}{4}$ " x 20 $\frac{1}{4}$ " x 18"

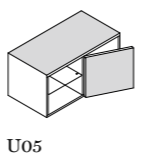
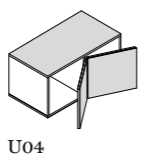
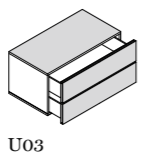
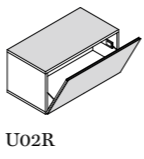
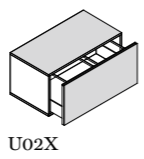
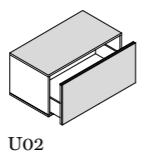
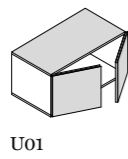
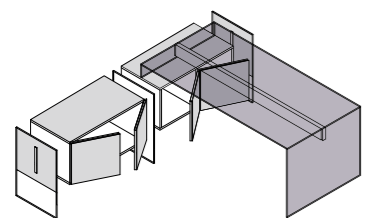

Il sistema Air può essere abbinato alla boiserie Elle Plus 10.	The Air system can be matched with Elle Plus 10 boiserie.	Le système Air peut être joint à la boiserie Elle Plus 10.	Das System Air kann mit Boiserie Elle Plus 10 verbunden werden.

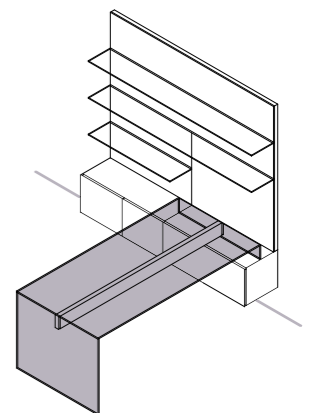



## Systems and Desks

- >> **Composizione Air Unit da 494x35x36h cm rivestita in cristallo specchiato "grigio Italia". Scrivania in appoggio in cristallo "grigio Italia" da 200x90x74h cm e parti metalliche in alluminio spazzolato nero. Elle Plus 10 Boiserie rivestita in tinto tabacco e cristallo specchiato "grigio Italia". Sedia OFX 09 h115 cm in pelle scamosciata Sand 012. Divano First in velluto blue 408. Tavolini Tetris.**
- Air Unit composition 494 x35x36h cm covered by smoked "grigio Italia" mirrored glass. Smoked "grigio Italia" glass desk with one side resting 200x90 x74h cm and black brushed aluminium metal parts. Elle Plus 10 Boiserie covered by tobacco stained and smoked "grigio Italia" mirrored glass. Chair OFX 09 h115 cm in suede Sand 012. First sofa in blue 408 velvet. Tetris coffee tables.**
- Composition Air Unit 494 x35x36h cm recouverte de verre miroité "grigio Italia" fumé. Bureau avec un côté posé, en verre "grigio Italia" fumé de 200 x90x74h cm et parties métalliques en aluminium brossé noir. Elle Plus 10 Boiserie recouvert en teinté tabac et verre miroité "grigio Italia" fumé. Chaise OFX 09 h115 cm en suède Sand 012. Canapé First en velours blue 408. Tables basses Tetris.**
- Komposition Air Unit 494x35x36h cm mit "grigio Italia" Rauchglas umkleidet. Schreibtisch aufgesetzt aus "grigio Italia" Rauchglas von 200 x90x74h cm und Metallteile Aluminium schwarz handgebürstet. Elle Plus 10 Boiserie mit Tabakfarbe gebeizt und "grigio Italia" Rauchglas umkleidet. Stuhl OFX 09 h115 cm Wildleder Sand 012. Sofa First Samt blue 408. Couchtische Tetris.**

**Esempi di postazione lavoro con il sistema Air Desk 1 e Air Unit.**

**Examples of working stations using the Air Desk 1 and Air Unit system.**

**Exemples de working stations avec le système Air Desk 1 et Air Unit.**

**Beispiele der Arbeitsplätze mit Air Desk 1 und Air Unit System.**

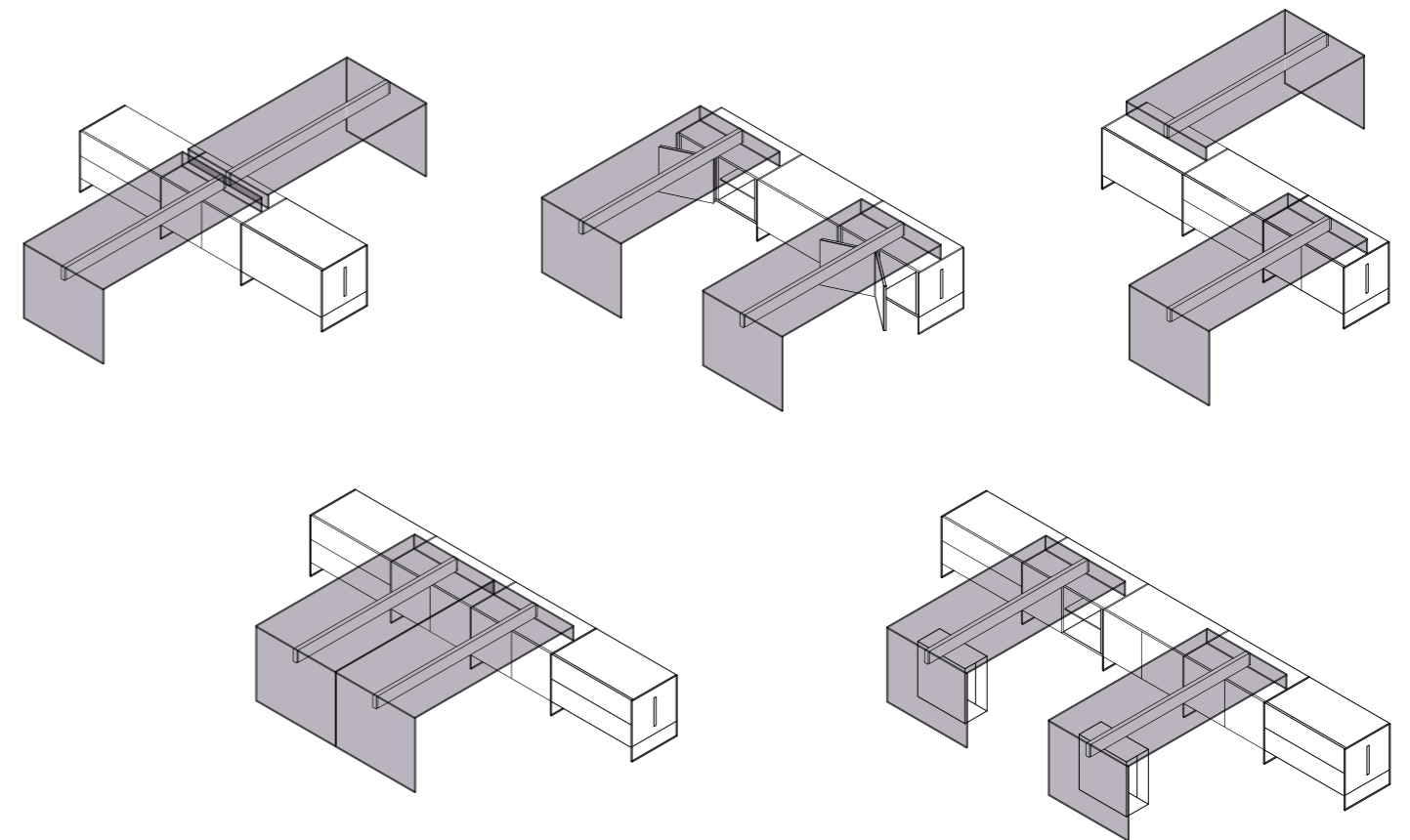



**Air Desk 1 Up**

Scrivania in appoggio su sistema Air Up in cristallo trasparente o "grigio Italia" temperato 12 mm. Disponibile con piano retroverniciato nei colori del campionario nella versione brillante o satinata. A richiesta piano in cristallo laminato effetto pelle. Parti metalliche in acciaio inox lucido, satinato oppure alluminio anodizzato, laccato bianco o nero goffrato. Su richiesta alluminio spazzolato a mano nei colori nero o titanio. Per consentire il passaggio dei cavi è possibile richiedere una foratura nel piano. Distanza minima dal bordo: 10 cm.

Desk with one side resting on Air Up system in 12 mm transparent or smoked "grigio Italia" tempered glass. Available also with painted glass top as per samples in the bright or satin version. Leather effect laminated glass top, on request. Bright or satin stainless steel, anodised aluminium or embossed metal parts. Hand brushed aluminium in the colours black or titanium grey, on request. For a proper cable management, a hole on the top can be arranged upon request. Minimum distance from the edge: 10 cm.

Bureau avec un côté posé sur Air Up système en verre transparent ou "grigio Italia" fumé trempé de 12 mms d'épaisseur. Disponible aussi avec plateau en verre verni dans les coloris de nos échantillons dans la version brillante ou satinée. Sur demande plateau en verre revêtu effet cuir. Parties métalliques en acier inox brillant, satiné ou en aluminium anodisé, laqué blanc ou noir gaufré. Sur demande aluminium brossé à la main dans les coloris noir ou gris titane. Pour permettre le passage des câbles un trou peut être réalisé dans le plateau. Distance minimum du bord: 10 cm.

Schreibtischkombination aufgesetzt auf Air Up Element: Glas vorgespannt klar oder Rauchglas "grigio Italia" 12 mm. Glas lieferbar auch lackiert nach Musterkarte. Lackierung jeweils hochglanz oder matt satiniert. Auf Wunsch Glasplatte mit Leder-Effekt umkleidet. Metallteile Edelstahl (Inox) poliert, gebürstet oder eloxiertes Aluminium oder weiss oder schwarz strukturlackiert. Lieferbar auch Aluminium handgebürstet in den Farben schwarz oder titan-grau. Kabel können durch eine zu bestellende Bohrung in der Platte geführt werden. Mindestabstand von der Kante: 10 cm.

> **Composizione Air Up** da 464x51x48,1h cm rivestita in cristallo retroverniciato visone brillante. Scrivanie in appoggio con piano laminato effetto pelle da 160x80x74h cm e parti metalliche in alluminio anodizzato. Sedie OFX 09 h85 cm in pelle scamosciata Sand 012.

**Air Up Composition 464** x51x48,1h cm covered by bright mink painted glass. Desks with one side resting with leather effect laminated glass top 160x80 x74h cm and anodised aluminium metal parts. Chairs OFX 09 h85 cm in suede Sand 012.

**Composition Air Up 464** x51x48,1h cm recouvert de verre verni vison brillant. Bureau avec un côté posé, avec plateau en verre revêtu effet cuir de 160x80 x74h cm et parties métalliques en aluminium anodisé. Chaises OFX 09 h85 cm en suédine Sand 012.

**Komposition Air Up 464** x51x48,1h cm mit Nerzfarbe hochglänzendem Glas umkleidet. Schreibtisch aufgesetzt mit Glasplatte mit Leder-Effekt umkleidet von 160x80 x74h cm und Metallteile eloxiertes Aluminium. Stühle OFX 09 h85 cm Wildleder Sand 012.

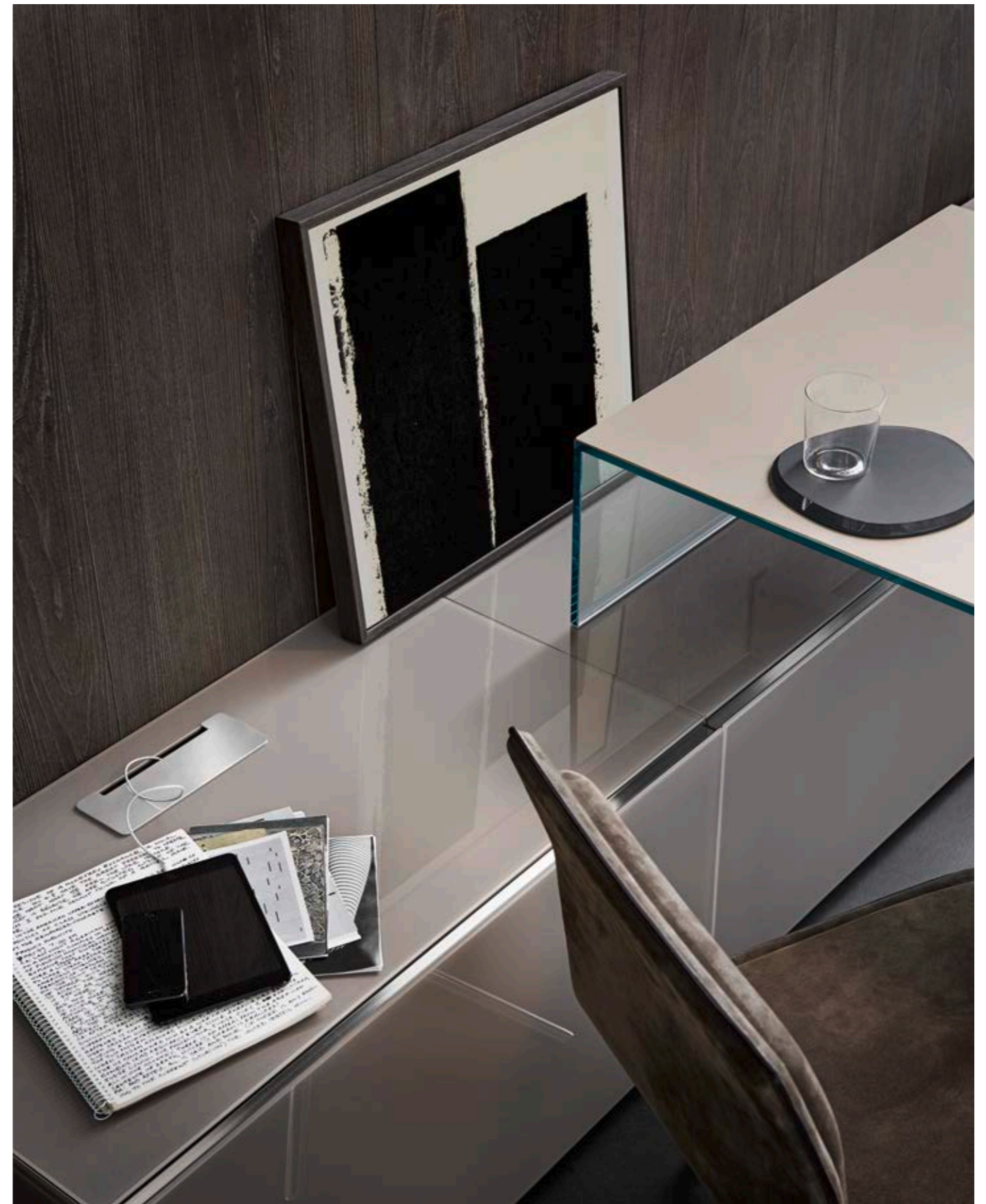



				Cm (L x P x H)	Inches (W x D x H)
La scrivania Air Desk 1 Up si posiziona sui moduli contenitori Air Up.	The Air Desk 1 Up shall rest on Air Up modules.	Le bureau Air Desk 1 Up se pose sur les meubles Air Up.	Der Schreibtisch Air Desk 1 Up soll auf Air Up-Möbel, gestellt werden.	120 x 80 x 74 140 x 80 x 74 160 x 80 x 74 180 x 90 x 74 200 x 90 x 74 120 x 120 x 74 140 x 120 x 74 160 x 120 x 74 180 x 120 x 74 200 x 120 x 74	47¼" x 31½" x 29¼" 55¼" x 31½" x 29¼" 63" x 31½" x 29¼" 71" x 35½" x 29¼" 78¾" x 35½" x 29¼" 47¼" x 47¼" x 29¼" 55¼" x 47¼" x 29¼" 63" x 47¼" x 29¼" 71" x 47¼" x 29¼" 78¾" x 47¼" x 29¼"

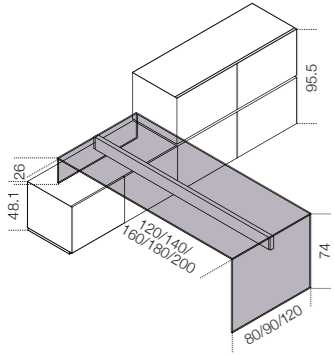

				Cm (L x P x H)	Inches (W x D x H)
La scrivania Air Desk 1 Up si posiziona sui moduli contenitori Air Up.	The Air Desk 1 Up shall rest on Air Up modules.	Le bureau Air Desk 1 Up se pose sur les meubles Air Up.	Der Schreibtisch Air Desk 1 Up soll auf Air Up-Möbel, gestellt werden.	120 x 80 x 74 140 x 80 x 74 160 x 80 x 74 180 x 90 x 74 200 x 90 x 74 120 x 120 x 74 140 x 120 x 74 160 x 120 x 74 180 x 120 x 74 200 x 120 x 74	47¼" x 31½" x 29¼" 55¼" x 31½" x 29¼" 63" x 31½" x 29¼" 71" x 35½" x 29¼" 78¾" x 35½" x 29¼" 47¼" x 47¼" x 29¼" 55¼" x 47¼" x 29¼" 63" x 47¼" x 29¼" 71" x 47¼" x 29¼" 78¾" x 47¼" x 29¼"

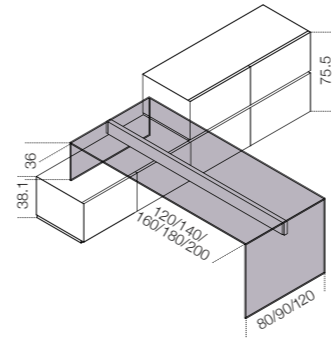

				Cm (L x P x H)	Inches (W x D x H)
La scrivania Air Desk 1 Up con profondità 47 cm si posiziona sul mobile Air Up nella modalità illustrata nel disegno.	The Air Desk 1 Up 47 cm deep shall rest on Air Up container as per above drawing.	Le bureau Air Desk 1 Up prof. 47 cm se pose sur le meuble Air Up selon dessin.	Der Schreibtisch Air Desk 1 Up (Tiefe 47 cm) soll auf Air Up Element wie die Skizze gestellt werden.	120 x 47 x 74 140 x 47 x 74 160 x 47 x 74 180 x 47 x 74	47¼" x 18¾" x 29¼" 55¼" x 18¾" x 29¼" 63" x 18¾" x 29¼" 71" x 18¾" x 29¼"

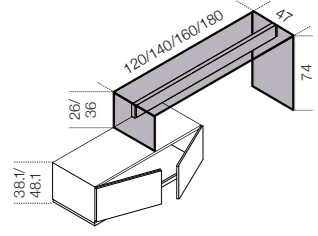

				Cm (L x P x H)	Inches (W x D x H)
Moduli contenitori Air Up S h 38.1 cm per Air Desk 1 Up.	Air Up S modules h 38.1 cm for Air Desk 1 Up.	Meubles Air Up S h 38.1 cm pour Air Desk 1 Up.	Air Up S-Möbel h 38.1 cm für Air Desk 1.	90 x 51 x 38.1 120 x 51 x 38.1	35½" x 20¼" x 15¼" 47¼" x 20¼" x 15¼"

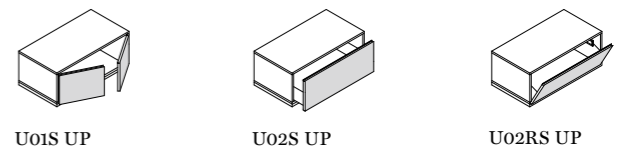
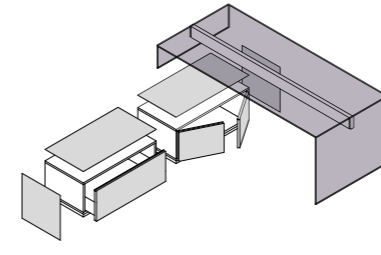

				Cm (L x P x H)	Inches (W x D x H)
Moduli contenitori Air Up h 48.1 cm per Air Desk 1 Up.	Air Up modules h 48.1 cm for Air Desk 1 Up.	Meubles Air Up h 48.1 cm pour Air Desk 1 Up.	Air Up-Möbel h 48.1 cm für Air Desk 1 Up.	90 x 51 x 48.1 120 x 51 x 48.1	35½" x 20¼" x 19" 47¼" x 20¼" x 19"

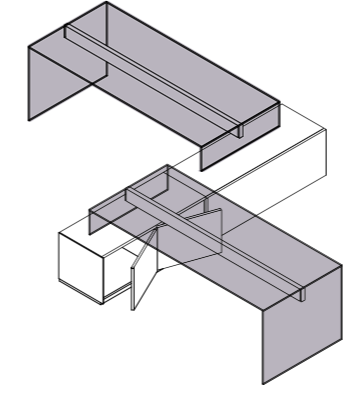
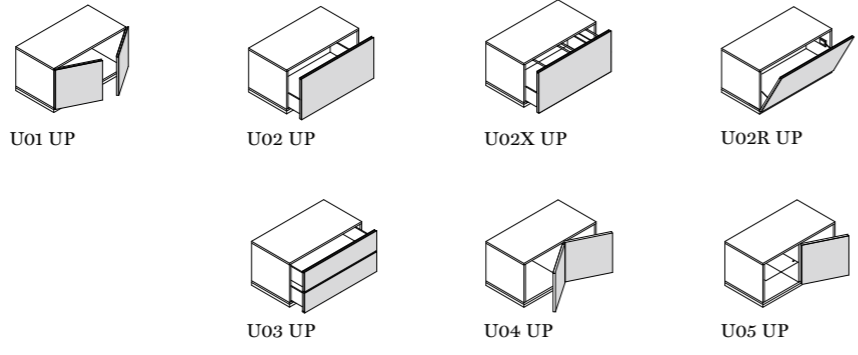
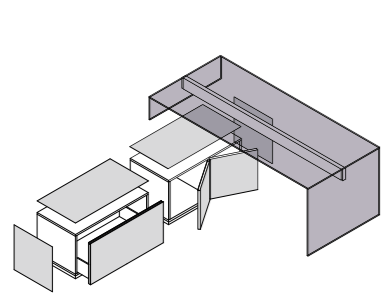

- |                                                                                                                                                                                                                                                                            |                                                                                                                                                                                                                                       |                                                                                                                                                                                                                                                        |                                                                                                                                                                                                                                       |
|----------------------------------------------------------------------------------------------------------------------------------------------------------------------------------------------------------------------------------------------------------------------------|---------------------------------------------------------------------------------------------------------------------------------------------------------------------------------------------------------------------------------------|--------------------------------------------------------------------------------------------------------------------------------------------------------------------------------------------------------------------------------------------------------|---------------------------------------------------------------------------------------------------------------------------------------------------------------------------------------------------------------------------------------|
| <p>&gt; Composizione Air Up da 482x51x95,5h cm rivestita in cristallo retroverniciato cemento satinato. Scrivania in appoggio in cristallo trasparente extralight da 180x90x74h cm e parti metalliche in alluminio anodizzato. Sedia OFX 09 h85 cm in ecopelle bianca.</p> | <p>Air Up composition 482 x51x95,5h cm covered by satin cement painted glass. Extralight transparent glass desk with one side resting 180x90x74h cm and anodised aluminium metal parts. Chair OFX 09 h85 cm in white eco-leather.</p> | <p>Composition Air Up 482 x51x95,5h cm recouverte de verre verni ciment satiné. Bureau avec un côté posé, en verre transparent extralight de 180x90x74h cm et parties métalliques en aluminium anodisé. Chaise OFX 09 h85 cm en simili cuir blanc.</p> | <p>Komposition Air Up 482 x51x95,5h cm mit zement matt satiniertem Glas umkleidet. Schreibtisch aufgesetzt aus Glas klar Extralight von 180x90x74h cm und Metallteile eloxiertes Aluminium. Stuhl OFX 09 h85 cm Spaltleder weiss.</p> |
| <p>v Dettaglio passacavi.</p>                                                                                                                                                                                                                                              | <p>Cable management detail.</p>                                                                                                                                                                                                       | <p>Détail du passage de câbles.</p>                                                                                                                                                                                                                    | <p>Detail der Kabeldurchlass.</p>                                                                                                                                                                                                     |

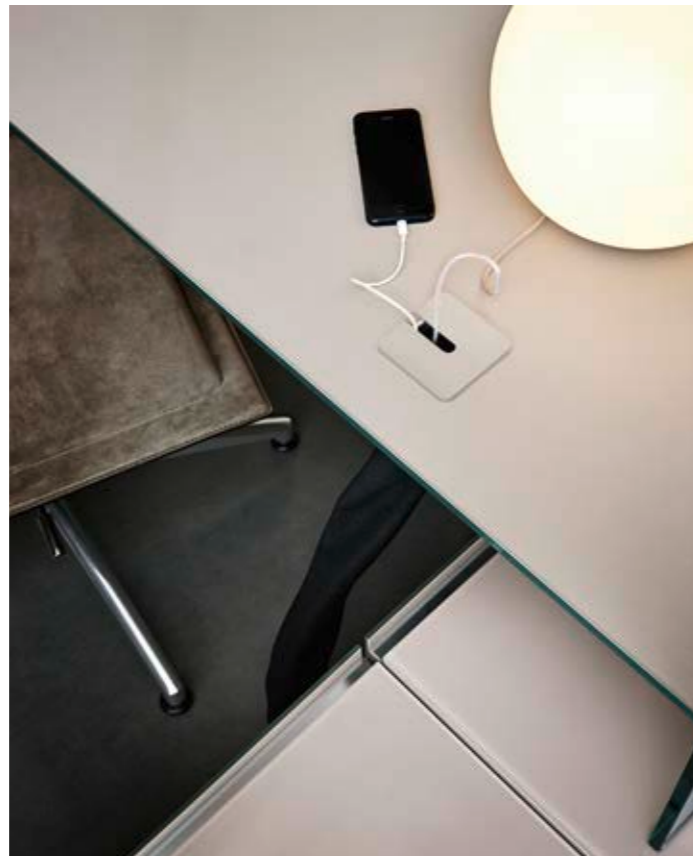





**Air Desk**

Scrivania in cristallo trasparente o "grigio Italia" temperato 12 mm. Disponibile con piano retroverniciato nei colori del campionario nella versione brillante o satinata. A richiesta piano in cristallo laminato effetto pelle. Parti metalliche in acciaio inox lucido, satinato oppure alluminio anodizzato o laccato bianco o nero gofrato. Su richiesta alluminio spazzolato a mano nei colori nero o titanio. Per consentire il passaggio dei cavi è possibile richiedere una foratura nel piano. Distanza minima dal bordo: 10 cm.

Desk in 12 mm transparent or smoked "grigio Italia" tempered glass. Available also with painted glass top as per samples in the bright or satin version. Leather effect laminated glass top, on request. Bright or satin stainless steel, anodised aluminium or embossed white or black lacquered metal parts. Hand brushed aluminium in the colours black or titanium grey, on request. For a proper cable management, a hole on the top can be arranged upon request. Minimum distance from the edge: 10 cm.

Bureau en verre transparent ou "grigio Italia" fumé trempé de 12 mm d'épaisseur. Disponible aussi avec plateau en verre verni dans les coloris de nos échantillons dans la version brillante ou satinée. Sur demande plateau en verre revêtu effet cuir. Parties métalliques en acier inox brillant, satiné ou en aluminium anodisé, laqué blanc ou noir gaufré. Sur demande aluminium brossé à la main dans les coloris noir ou gris titane. Pour permettre le passage des câbles un trou peut être réalisé dans le plateau. Distance minimum du bord: 10 cm.

Schreibtisch: Glas vorgespannt klar oder Rauchglas "grigio Italia" 12 mm. Glas lieferbar auch lackiert nach Musterkarte. Lackierung jeweils hochglanz oder matt satiniert. Auf Wunsch Glasplatte mit Leder-Effekt umkleidet. Metallteile Edelstahl (Inox) poliert, gebürstet oder eloxiertes Aluminium oder weiss oder schwarz strukturlackiert. Lieferbar auch Aluminium handgebürstet in den Farben schwarz oder titangrau. Kabel können durch eine zu bestellende Bohrung in der Platte geführt werden. Mindestabstand von der Kante: 10 cm.

> Scrivania in cristallo trasparente extralight da 200x90x74h cm e parti metalliche in acciaio inox lucido. Sedia OFX 09 h115 cm in pelle scamosciata Sand 012. Boiserie Elle Plus 10 da 481x28,5x140h cm rivestita in cristallo retroverniciato champagne satinato. Composizione Air Unit pensile da 482x35x36 cm rivestita in cristallo retroverniciato champagne satinato.

Extralight transparent glass desk 200x90x74h cm and bright stainless steel metal parts. Chair OFX 09 h115 cm in suede Sand 012. Elle Plus 10 boiserie 481x28,5x140h cm covered by satin champagne painted glass. Air Unit suspended composition 482x35x36 cm covered by satin champagne painted glass.

Bureau en verre transparent extralight de 200x90x74h cm et parties métalliques en acier inox brillant. Chaise OFX 09 h115 cm en suédine Sand 012. Elle Plus 10 boiserie de 481x28,5x140h cm recouvert de verre verni champagne satiné. Composition murale Air Unit de 482x35x36 cm recouverte de verre verni champagne satiné.

Schreibtisch aus Glas klar Extralight von 200x90x74h cm und Metallteile Edelstahl (Inox) poliert. Stuhl OFX 09 h115 cm Wildleder Sand 012. Elle Plus 10 Boiserie 481x28,5x140h cm mit champagne matt satiniertem Glas umkleidet. Hänge-Komposition Air Unit 482x35x36 cm mit champagne matt satiniertem Glas umkleidet.

Air Desk

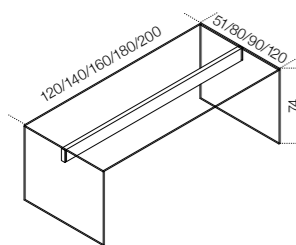

Air Desk L

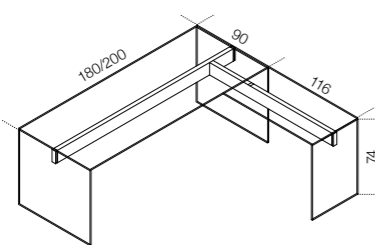

Air Desk

## Cm (L x P x H)

120 x 51 x 74
140 x 51 x 74
160 x 51 x 74
120 x 80 x 74
140 x 80 x 74
160 x 80 x 74
180 x 90 x 74
200 x 90 x 74
120 x 120 x 74
140 x 120 x 74
160 x 120 x 74
180 x 120 x 74
200 x 120 x 74
180 x 206 x 74
200 x 206 x 74

Air Desk L

## Inches (W x D x H)

47¼" x 20¼" x 29¼"
55¼" x 20¼" x 29¼"
63" x 20¼" x 29¼"
47¼" x 31½" x 29¼"
55¼" x 31½" x 29¼"
63" x 31½" x 29¼"
71" x 35½" x 29¼"
78¾" x 35½" x 29¼"
47¼" x 47¼" x 29¼"
55¼" x 47¼" x 29¼"
63" x 47¼" x 29¼"
71" x 47¼" x 29¼"
78¾" x 47¼" x 29¼"
71" x 81¼" x 29¼"
78¾" x 81¼" x 29¼"





**Air Desk W**

Scrivania in cristallo trasparente o "grigio Italia" temperato 12 mm. Disponibile con piano retroverniciato nei colori del campionario nella versione brillante o satinata. Parti metalliche in acciaio inox lucido, satinato oppure alluminio anodizzato o laccato bianco o nero goffrato. Su richiesta alluminio spazzolato a mano nei colori nero o titanio. Cassetto in frassino naturale o tinto tabacco. Vano predisposto per cablaggio.

Desk with 12 mm transparent or smoked "grigio Italia" tempered glass. Available also with painted glass top as per samples in the bright or satin version. Bright or satin stainless steel, anodised aluminium or embossed metal parts. Hand brushed aluminium in the colours black or titanium grey, on request. Drawer in natural ash or tobacco stained. Equipped unit for cable management.

Bureau en verre transparent ou "grigio Italia" fumé trempé de 12 mms d'épaisseur. Disponible avec plateau en verre verni dans les coloris de nos échantillons dans la version brillante ou satinée. Parties métalliques en acier inox brillant, satiné ou en aluminium anodisé ou laqué blanc ou noir gaufré. Sur demande aluminium brossé à la main dans les coloris noir ou gris titane. Tiroir en frêne naturel ou teinté tabac. Pièce préparé pour le passage des câbles.

Schreibtisch: Glas vorgepannt klar oder Rauchglas "grigio Italia" 12 mm. Glas lieferbar auch lackiert nach Musterkarte. Lackierung jeweils hochglanz oder matt satiniert. Metallteile Edelstahl (Inox) poliert, gebürstet oder eloxiertes Aluminium oder weiss oder schwarz strukturlackiert. Lieferbar auch Aluminium handgebürstet in den Farben schwarz oder titangrau. Holzschublade Eschenholz natur oder Tabakfarbe gebeizt. Ein Fach für die Verkabelung verwendet.

> Scrivania in cristallo "grigio Italia" da 160x65x74h cm. Parti metalliche in alluminio spazzolato a mano nero. Cassetto in frassino tinto tabacco.

Smoked "grigio Italia" glass desk 160x65x74h cm. Black hand brushed aluminium metal parts. Drawer in tobacco stained ash.

Bureau en verre "grigio Italia" fumé de 160x65x74h cm. Parties métalliques en aluminium brossé noir. Tiroir en frêne teinté tabac.

Schreibtisch: Rauchglas "grigio Italia" 160x65x74h cm. Metallteile Aluminium schwarz handgebürstet. Holzschublade Tabakfarbe gebeizt.

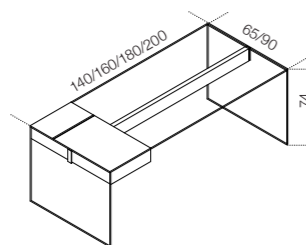
**Cm (L x P x H)**

140 x 65 x 74  
160 x 65 x 74  
180 x 65 x 74  
200 x 90 x 74

**Inches (W x D x H)**

55¼" x 25¾" x 29¼"  
63" x 25¾" x 29¼"  
71" x 25¾" x 29¼"  
78¾" x 35½" x 29¼"



**Air Desk Console**

Console in cristallo trasparente o "grigio Italia" temperato 12 mm. Disponibile con piano retroverniciato nei colori del campionato nella versione brillante o satinata. A richiesta piano in cristallo laminato effetto pelle. Parti metalliche in acciaio inox lucido, satinato oppure alluminio anodizzato o laccato bianco o nero gofrato. Su richiesta alluminio spazzolato a mano nei colori nero o titanio. Per consentire il passaggio dei cavi è possibile richiedere una foratura nel piano. Distanza minima dal bordo: 10 cm.

Console in 12 mm transparent or smoked "grigio Italia" tempered glass. Available also with painted glass top as per samples in the bright or satin version. Leather effect laminated glass top, on request. Bright or satin stainless steel, anodised aluminium or embossed white or black lacquered metal parts. Hand brushed aluminium in the colours black or titanium grey, on request. For a proper cable management, a hole on the top can be arranged upon request. Minimum distance from the edge: 10 cm.

Console en verre transparent ou "grigio Italia" fumé trempé de 12 mm d'épaisseur. Disponible aussi avec plateau en verre verni dans les coloris de nos échantillons dans la version brillante ou satinée. Sur demande plateau en verre revêtu effet cuir. Parties métalliques en acier inox brillant, satiné ou en aluminium anodisé, laqué blanc ou noir gaufré. Sur demande aluminium brossé à la main dans les coloris noir ou gris titane. Pour permettre le passage des câbles un trou peut être réalisé dans le plateau. Distance minimum du bord: 10 cm.

Konsole: Glas vorgespannt klar oder Rauchglas "grigio Italia" 12 mm. Glas lieferbar auch lackiert nach Musterkarte. Lackierung jeweils hochglanz oder matt satiniert. Auf Wunsch Glasplatte mit Leder-Effekt umkleidet. Metallteile Edelstahl (Inox) poliert, gebürstet oder eloxiertes Aluminium oder weiss oder schwarz strukturlackiert. Lieferbar auch Aluminium handgebürstet in den Farben schwarz oder titangrau. Kabel können durch eine zu bestellende Bohrung in der Platte geführt werden. Mindestabstand von der Kante: 10 cm.

> Console in cristallo trasparente extralight da 160x51x74h cm e parti metalliche in acciaio inox lucido. Cassettiera Air Drawer in cristallo retroverniciato champagne satinato. Sedia OFX 09 h85 cm in pelle scamosciata Sand 012.

Extralight transparent glass console 160x51x74h cm and bright stainless steel metal parts. Air Drawer covered by satin champagne painted glass. Chair OFX 09 h85 cm in suede Sand 012.

Console en verre transparent extralight de 160x51x74h cm et parties métalliques en acier inox brillant. Air Drawer bloc tiroir recouvert de verre verni champagne satiné. Chaise OFX 09 h85 cm en suédine Sand 012.

Konsole aus Glas klar Extralight von 160x51x74h cm und Metallteile Edelstahl (Inox) poliert. Air Drawer Rollecontainer mit champagne matt satiniertem Glas umkleidet. Stuhl OFX 09 h85 cm Wildleder Sand 012.

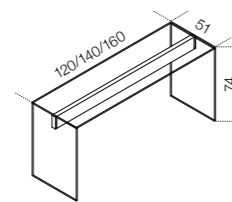
**Cm (L x P x H)**

120 x 51 x 74  
140 x 51 x 74  
160 x 51 x 74

**Inches (W x D x H)**

47¼" x 20¼" x 29¼"  
55¼" x 20¼" x 29¼"  
63" x 20¼" x 29¼"

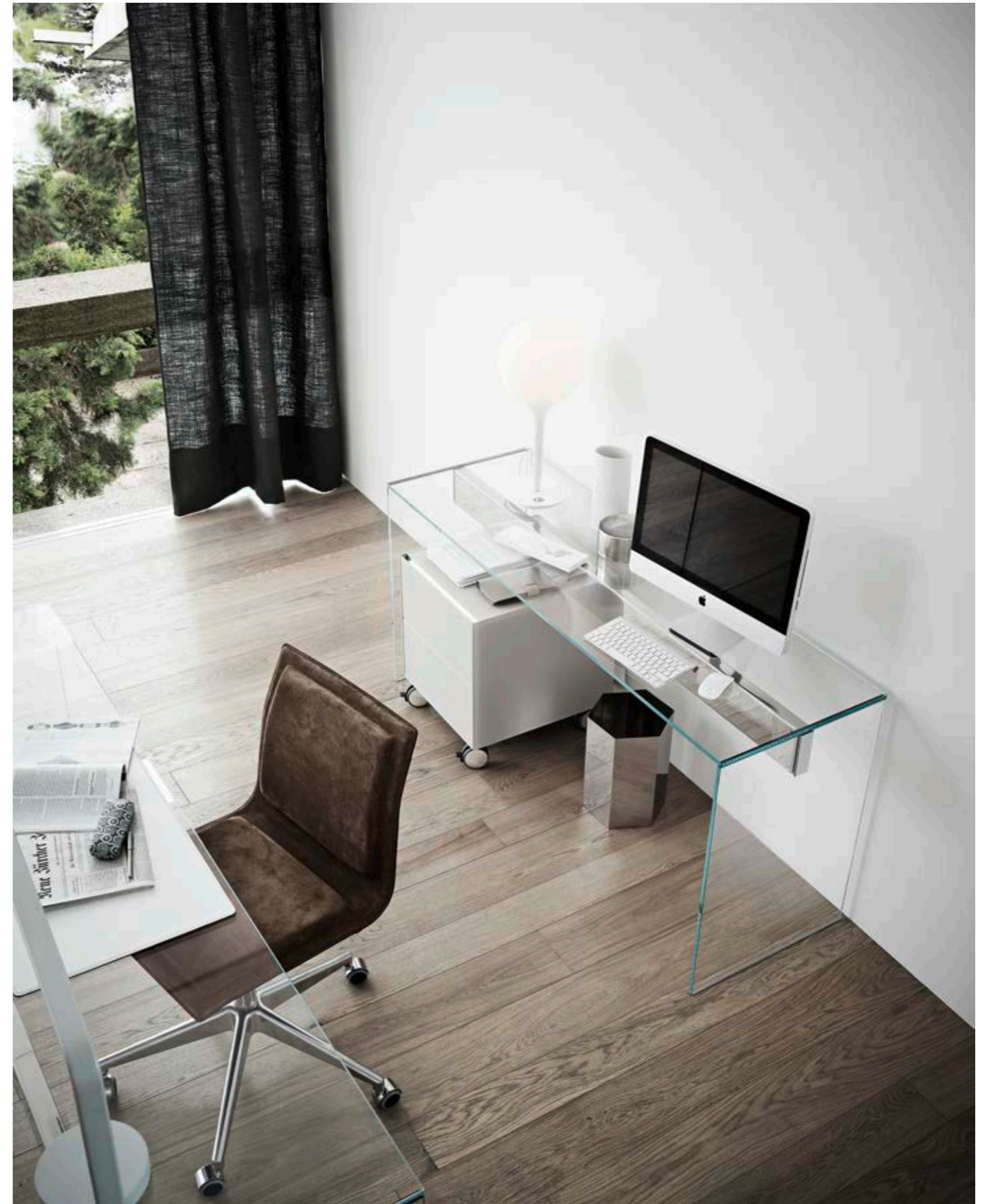

**Air Desk Modesty**

Scrivania per reception con piano temperato 12 mm retroverniciato nei colori del campionario nella versione brillante o satinata. A richiesta piano in cristallo laminato effetto pelle e spalle in cristallo trasparente o "grigio Italia". Pannello frontale laminato effetto pelle. Disponibile anche laccato bianco o nero gofrato o laccato effetto tessuto nei colori castagna, sabbia e canapa. Parti metalliche in acciaio inox lucido, satinato oppure alluminio anodizzato o laccato bianco o nero gofrato. Su richiesta alluminio spazzolato a mano nero.

Reception desk with 12 mm tempered painted glass top as per samples in the bright or satin version. Leather effect laminated glass top and transparent or smoked "grigio Italia" glass sides, on request. Frontal panel leather effect laminated. Available also embossed white or black lacquered or with "fabric" touch effect lacquered in the colours chestnut, sand and canapa. Bright or satin stainless steel, anodised aluminium or embossed aluminium metal parts. Black hand brushed aluminium, on request.

Bureau pour la réception avec plateau en verre trempé de 12 mms d'épaisseur verni dans les coloris de nos échantillons dans la version brillante ou satinée. Sur demande plateau en verre revêtu effet cuir et côtés en verre transparent ou "grigio Italia" fumé. Panneau frontal revêtu effet cuir. Disponible aussi laqué blanc ou noir gaufré ou laqué avec effet tissu dans les coloris châtaigne, sablé et chanvre. Parties métalliques en acier inox brillant, satiné ou en aluminium anodisé, laqué blanc ou noir gaufré. Sur demande aluminium brossé à la main noir.

Empfangsschreibtisch: Glasplatte vorgespannt 12 mm lackiert nach Musterkarte. Lackierung jeweils hochglanz oder matt satiniert. Auf Wunsch Glasplatte mit Leder-Effekt umkleidet und Seitenwangen Glas klar oder Rauchglas "grigio Italia". Frontpaneel mit Leder-Effekt umkleidet. Lieferbar auch weiss oder schwarz strukturlackiert oder lackiert mit Stoff-Effekt in kastanienbraun, sandfarben und hanffarben. Metallteile Edelstahl (Inox) poliert, gebürstet oder eloxiertes Aluminium oder weiss oder schwarz strukturlackiert. Lieferbar auch Aluminium schwarz handgebürstet.

> Scrivania per reception da 300x90x74h/105h cm con piano in cristallo "grigio Italia" laminato effetto pelle e spalle in cristallo "grigio Italia". Pannello frontale laminato effetto pelle. Parti metalliche alluminio spazzolato nero. Sedia OFX 09 h85 cm in pelle scamosciata Sand 012. Lampada Bolle.

Reception desk 300x90x74h/105h cm with smoked "grigio Italia" leather effect laminated glass top and smoked "grigio Italia" glass sides. Leather effect laminated front panel. Black hand brushed aluminium metal parts. Chair OFX 09 h85 cm in suede Sand 012. Bolle lamp.

Bureau pour la réception de 300x90x74h/105h cm avec plateau en verre "grigio Italia" fumé revêtu effet cuir et côtés en verre "grigio Italia" fumé. Panneau frontal revêtu effet cuir. Parties métalliques en aluminium brossé noir. Chaise OFX 09 h85 cm en suédine Sand 012. Lampe Bolle.

Empfangsschreibtisch 300x90x74h/105h cm: Glasplatte Rauchglas "grigio Italia" mit Leder-Effekt umkleidet und Seiten Rauchglas "grigio Italia". Frontpaneel mit Leder-Effekt umkleidet. Metallteile Aluminium schwarz handgebürstet. Stuhl OFX 09 h85 cm Wildleder Sand 012. Lampe Bolle.

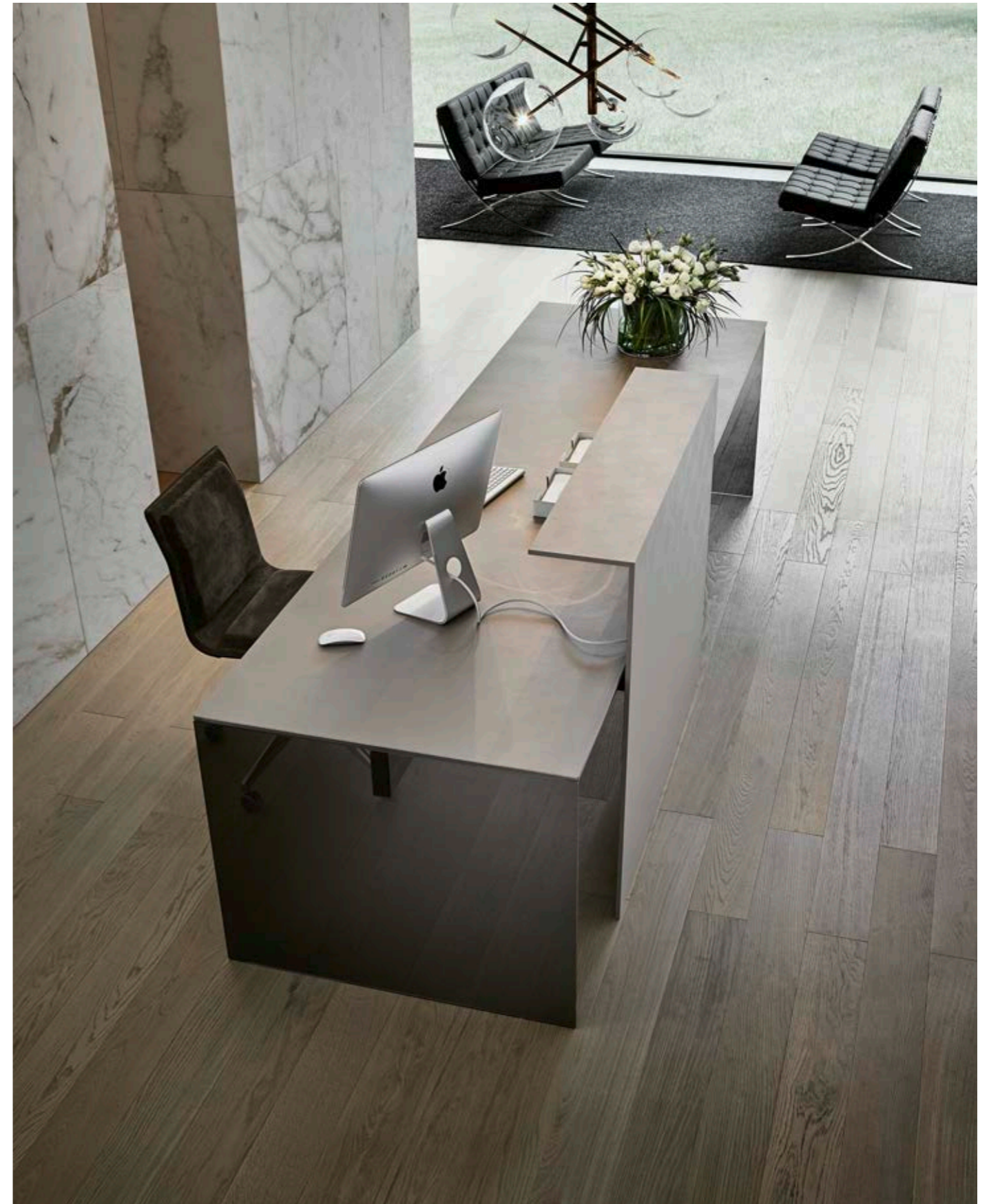



> Scrivania per reception da 300x90x74h/105h cm con piano in cristallo "grigio Italia" laminato effetto pelle e spalle in cristallo "grigio Italia". Pannello frontale laminato effetto pelle. Parti metalliche alluminio spazzolato nero. Cassettera Air Drawer in cristallo retroverniciato visone satinato. Sedia OFX 09 h85 cm in pelle scamosciata Sand 012.

Reception desk 300x90 x74h/105h cm with smoked "grigio Italia" leather effect laminated glass top and smoked "grigio Italia" glass sides. Leather effect laminated front panel. Black hand brushed aluminium metal parts. Air Drawer covered by satin mink painted glass. Chair OFX 09 h85 cm in suede Sand 012.

Bureau pour la réception de 300x90x74h/105h cm avec plateau en verre "grigio Italia" fumé revêtu effet cuir et côtés en verre "grigio Italia" fumé. Panneau frontal revêtu effet cuir. Parties métalliques en aluminium brossé noir. Air Drawer bloc tiroir recouvert de verre verni vison satiné. Chaise OFX 09 h85 cm en suédine Sand 012.

Empfangsschreibtisch 300x90x74h/105h cm: Glasplatte Rauchglas "grigio Italia" mit Leder-Effekt umkleidet und Seiten Rauchglas "grigio Italia". Frontpaneel mit Leder-Effekt umkleidet. Metallteile Aluminium schwarz handgebürstet. Air Drawer Rollcontainer mit Nerzfarbe matt satiniertem Glas umkleidet. Stuhl OFX 09 h85 cm Wildleder Sand 012.

√ La versione XL da 260x110 cm prevede una spalla intermedia.

The XL version, from 260x110 cm, includes one middle glass side.

La version XL, à partir de 260x110 cm, est réalisée avec une côté intermédiaire.

Die XL-Ausführung ab 260x110 cm wird mit einer Zwischenseitenwange geliefert.

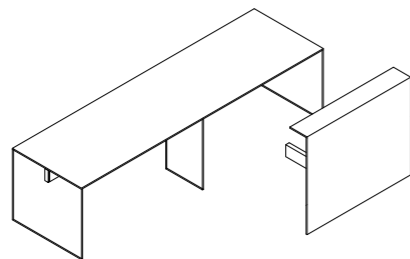

√ La distanza tra il piano e il pannello frontale è di 12 mm e permette il passaggio dei cavi.

The distance between the top and the front panel of the desk is 12 mm and allows the cable connection.

La distance entre le plateau et le panneau frontal est de 12 mms et permet les passage des câbles.

Der Abstand zwischen der Glasplatte und dem Frontpaneel ist 12 mm und ist für den Kabeldurchlass geeignet.

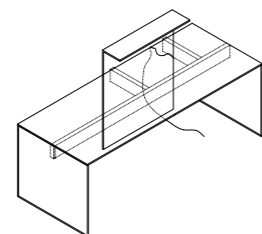

Air Desk Modesty

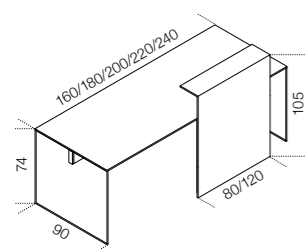

Air Desk Modesty XL

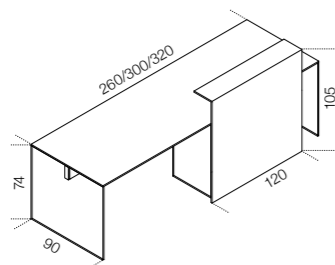

Air Desk Modesty

## Cm (L x P x H)

160 x 80 x 74/105  
180 x 90 x 74/105  
200 x 90 x 74/105  
220 x 90 x 74/105  
240 x 90 x 74/105  
260 x 90 x 74/105  
300 x 90 x 74/105  
320 x 90 x 74/105

Air Desk Modesty XL

## Inches (W x D x H)

63" x 31½" x 29¼"/41½"  
71" x 35½" x 29¼"/41½"  
78¾" x 35½" x 29¼"/41½"  
86¾" x 35½" x 29¼"/41½"  
94½" x 35½" x 29¼"/41½"  
102½" x 35½" x 29¼"/41½"  
118¼" x 35½" x 29¼"/41½"  
126" x 35½" x 29¼"/41½"



**Air Desk Hall**

Scrivania per reception in cristallo temperato 12 mm retroverniciato nei colori del campionario nella versione brillante o satinata. Disponibile con pannello frontale e spalle in cristallo retroverniciato nei colori del campionario nella versione brillante o satinata (Opzioni A, B, C e D). Parti metalliche in acciaio inox lucido, satinato oppure alluminio anodizzato, laccato bianco o nero goffrato. Su richiesta alluminio spazzolato a mano nei colori nero o titanio. Per consentire il passaggio dei cavi è possibile richiedere una foratura nel piano. Distanza minima dal bordo: 10 cm.

Reception desk in 12 mm tempered painted glass top as per samples in the bright or satin version. Available also with front panel and sides in painted glass as per samples in the bright or satin version (Options A, B, C and D). Bright or satin stainless steel, anodised aluminium or embossed white or black lacquered metal parts. Hand brushed aluminium in the colours black or titanium grey, on request. For a proper cable management, a hole on the top can be arranged upon request. Minimum distance from the edge: 10 cm.

Bureau pour la réception en verre trempé de 12 mms d'épaisseur avec plateau en verre verni dans les coloris de nos échantillons dans la version brillante ou satinée. Disponible avec panneau frontal et côtés vernis dans les coloris de nos échantillons dans la version brillante ou satinée (Options A, B, C et D). Parties métalliques en acier inox brillant, satiné ou en aluminium anodisé, laqué blanc ou noir gaufré. Sur demande aluminium brossé à la main dans les coloris noir ou gris titane. Pour permettre le passage des câbles un trou peut être réalisé dans le plateau. Distance minimum du bord: 10 cm.

Empfangsschreibtisch: Glasplatte vorgespannt 12 mm lackiert nach Musterkarte. Lackierung jeweils hochglanz oder matt satiniert. Lieferbar mit Frontpaneel und Seiten Glas lackiert nach Musterkarte. Lackierung jeweils hochglanz oder matt satiniert (Optionen A, B, C und D). Metallteile Edelstahl (Inox) poliert, gebürstet oder eloxiertes Aluminium oder weiss oder schwarz strukturlackiert. Lieferbar auch Aluminium handgebürstet in den Farben schwarz oder titangrau. Kabel können durch eine zu bestellende Bohrung in der Platte geführt werden. Mindestabstand von der Kante: 10 cm.

> Scrivania per reception in cristallo retroverniciato champagne da 200x90x74/100h cm e parti metalliche in acciaio inox lucido.

Reception desk with champagne painted glass 200x90x74/100h cm and bright stainless steel metal parts.

Bureau pour la réception en verre verni champagne de 200x90x74/100h cm et parties métalliques en acier inox brillant.

Empfangsschreibtisch mit champagne matt Glas 200x90x74/100h cm und Metallteile Edelstahl (Inox) poliert.

v Suggestimenti per la retroverniciatura

Proposals for painted glass parts

Suggestions pour le verre verni

Vorschläge für Glas lackiert

A

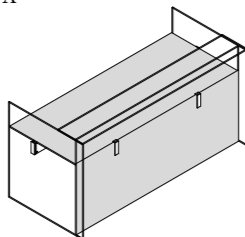

B

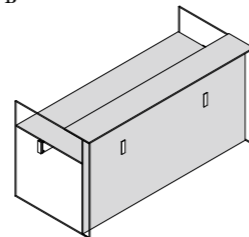

C

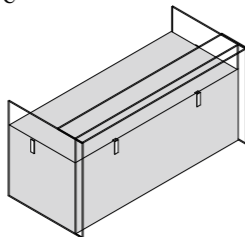

D

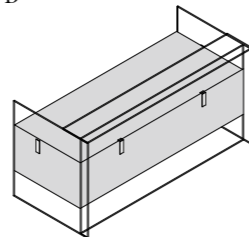





Systems and Desks

- < Scrivania per reception con piano in cristallo retroverniciato bianco satinato da 200x90 x74/100h cm e parti metalliche in acciaio inox lucido. Sottomano Air Pad in alluminio verniciato bianco effetto gomma.
  - Reception desk with satin white painted glass top 200x90x74/100h cm and bright stainless steel metal parts. Air Pad writing pad in white lacquered aluminium "rubber finish".
  - Bureau pour la réception avec plateau en verre blanc satiné de 200x90 x74/100h cm et parties métalliques en acier inox brillant. Air Pad sous-main en aluminium laqué blanc "finition caoutchouc".
  - Empfangsschreibtisch mit weiss matt satiniertes Glasplatte 200x90x74/100h cm und Metallteile Edelstahl (Inox) poliert. Air Pad Schreibunterlage Aluminium weiss Weichkunststoff-lackiert.
- v Suggestimenti per soluzioni personalizzate.
  - Suggestions for customised options.
  - Suggestions pour solutions personnalisées.
  - Vorschläge für die persönliche Ausführungen.

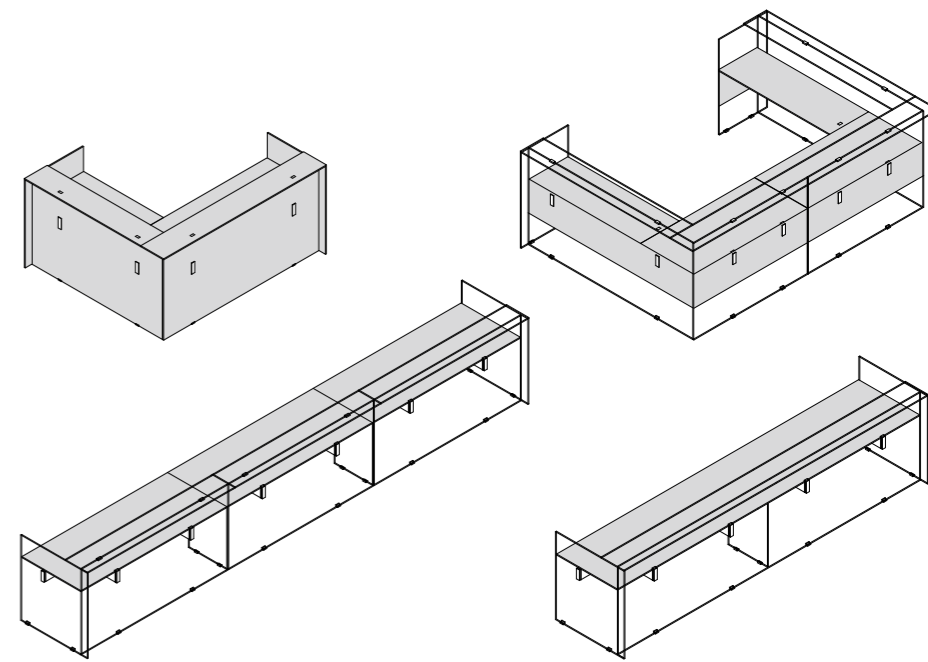

	Cm (L x P x H)	Inches (W x D x H)
Air Desk Hall	160 x 80 x 74/100	63" x 31½" x 29¼"/39½"
Air Desk Hall XL	180 x 90 x 74/100	71" x 35½" x 29¼"/39½"
	200 x 90 x 74/100	78¾" x 35½" x 29¼"/39½"
	220 x 90 x 74/100	86¾" x 35½" x 29¼"/39½"
	260 x 90 x 74/100	102½" x 35½" x 29¼"/39½"
	300 x 90 x 74/100	118¾" x 35½" x 29¼"/39½"
	320 x 90 x 74/100	126" x 35½" x 29¼"/39½"

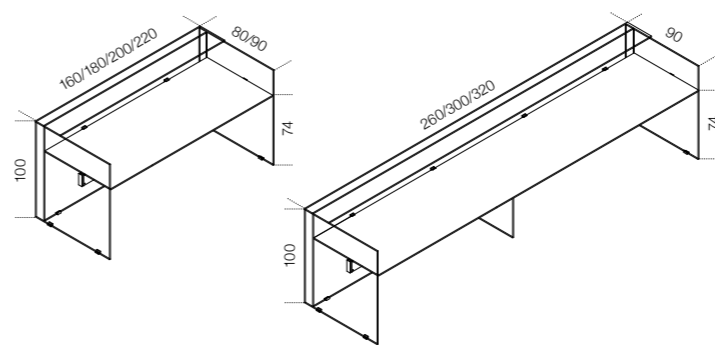

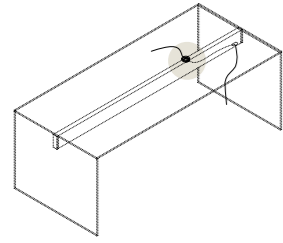
**Air Cable**

Sistema di forature per consentire il passaggio dei cavi nella trave delle scrivanie Air.

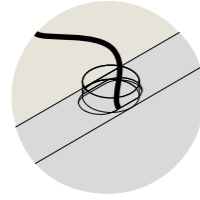

Drilling system for the cable management in the Air desks' metal bar.

Système de perçage pour permettre le passage des câbles dans la barre des bureaux Air.

Bohrungsmuster für die Kabeldurchlass im Metallbalken des Schreibtisches Air.

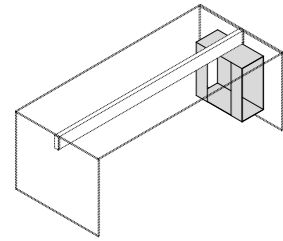
**Air Tower**

Elemento portatower in lamiera metallica verniciata bianco o nero goffrato da fissare alle scrivanie Air Desk.

Computer case holder in embossed white or black lacquered metal sheet to be fixed to Air Desks.

Porte-tower en tôle métallique vernie blanc ou noir gaufré à fixer sous les bureaux Air Desk.

Computer-case-möbel aus Metall weiss oder schwarz strukturlackiert unter den Schreibtischen Air Desk zu befestigen.

Cm (L x P x H)  
50 x 23 x 50

Inches (W x D x H)  
19¾" x 9¼" x 19¾"

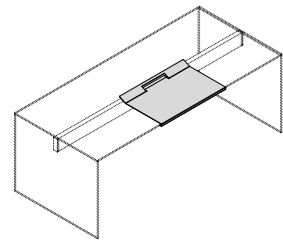
**Air Pad**

Sottomano in alluminio verniciato bianco o nero effetto gomma. Vedi a pagina 46.

White or black lacquered aluminium writing pad "rubber finish". See at page 46.

Sous-main en aluminium verni blanc ou noir "finition caoutchouc". Voir à la page 46.

Schreibunterlage aus Aluminium weiss oder schwarz Weichkunststoff-lackiert. Siehe auf Seite 46.

Cm (L x P x H)  
65 x 43 x 2

Inches (W x D x H)  
25¾" x 17" x 1"



# WGS

Scrivania con piano in cristallo trasparente o "grigio Italia" temperato 12 mm. A richiesta retrovernicciato nei colori del campionario nella versione brillante o satinata. Base in rovere spazzolato naturale, tinto wengé, laccato bianco o nero a poro aperto. Parti metalliche in acciaio inox lucido.

Desk with 12 mm transparent or smoked "grigio Italia" tempered glass top. Painted glass as per sample in the bright or satin version, on request. Brushed natural oak, wengé stained, white or black open pore lacquered base. Bright stainless steel metal parts.

Bureau avec plateau en verre transparent ou "grigio Italia" fumé trempé de 12 mms d'épaisseur. Sur demande aussi en verre verni dans les couleurs de nos échantillons dans la version brillante ou satinée. Piètement en chêne naturel brossé, teinté wengé, laqué blanc ou noir pores ouverts. Parties métalliques en acier inox brillant.

Schreibtisch: Glasplatte vorgespannt klar oder Rauchglas "grigio Italia" 12 mm. Glas lieferbar auch lackiert nach Musterkarte. Lackierung jeweils hochglanz oder matt satiniert. Gestell Eiche natur gebürstet, Wengé gebeizt, weiss oder schwarz lackiert offenporig. Metallteile Edelstahl (Inox) poliert.

> Scrivania in cristallo trasparente extralight da 160x65x73h cm e base in rovere tinto wengé. Boiserie Elle Plus 10 in cristallo retrovernicciato grigio umbro satinato. Sedia OFX 09 h85 cm in pelle scamosciata Grey 074.

Extralight transparent glass desk 160x65x73h cm and wengé stained oak base. Elle Plus 10 boiserie covered by satin dark grey painted glass. Chair OFX 09 h85 cm in suede Grey 074.

Bureau en verre transparent extralight de 160x65x73h cm et piètement en chêne teinté wengé. Elle Plus 10 boiserie recouvert de verre verni gris foncé satiné. Chaise OFX 09 h85 cm en suédine Grey 074.

Schreibtisch Glas klar Extralight 160x65x73h und Gestell Eiche Wengé gebeizt. Elle Plus 10 Boiserie mit dunkel grau matt satiniertem Glas umkleidet. Stuhl OFX 09 h85 cm Wildleder Grey 074.

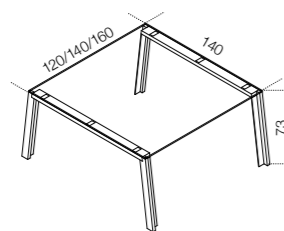
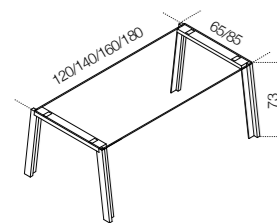

#### Cm (L x P x H)

120 x 65 x 73  
140 x 65 x 73  
160 x 65 x 73  
140 x 85 x 73  
160 x 85 x 73  
180 x 85 x 73  
120 x 140 x 73  
140 x 140 x 73  
160 x 140 x 73

#### Inches (W x D x H)

47¼" x 25¾" x 28¾"  
55¼" x 25¾" x 28¾"  
63" x 25¾" x 28¾"  
55¼" x 33½" x 28¾"  
63" x 33½" x 28¾"  
71" x 33½" x 28¾"  
47¼" x 55¼" x 28¾"  
55¼" x 55¼" x 28¾"  
63" x 55¼" x 28¾"

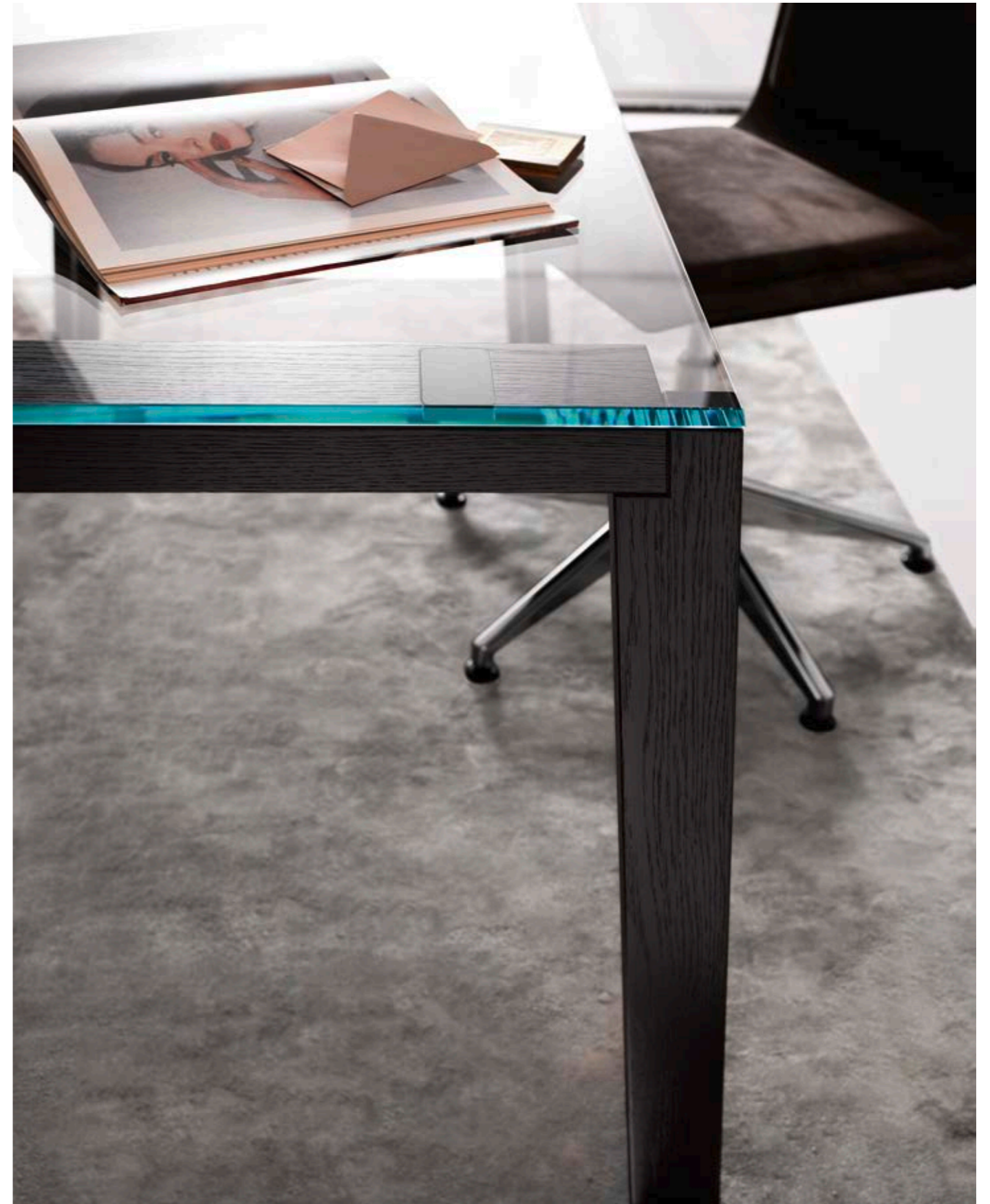



**WGS Double**

Sistema modulare di scrivanie con piano in cristallo trasparente o "grigio Italia" temperato 12 mm. A richiesta retroverniciato nei colori del campionario, nella versione brillante o satinata. Base in rovere spazzolato naturale, tinto wengé, laccato bianco o nero poro aperto. Parti metalliche in acciaio inox lucido. Il "cavalletto doppio", che consente il collegamento tra più moduli, è predisposto per il passaggio dei cavi e dotato di una fascia di chiusura in feltro, ecopelle o tessuto nei colori del campionario. Si presta per l'inserimento degli accessori (WGS Shelf, WGS Glove, WGS Tolomeo, WGS Bar Tray e WGS Screen).

Modular system of desks with 12 mm transparent or smoked "grigio Italia" tempered glass top. Painted glass, as per samples, in the bright or satin version, on request. Brushed natural oak, wengé stained, white or black open pore lacquered base. Bright stainless steel metal parts. The "double leg", suitable for cable runway and supplied with cover band made in felt, eco-leather or fabric as per samples, is required for the modules connection and allows insertion of accessories (WGS Shelf, WGS Glove, WGS Tolomeo, WGS Bar Tray and WGS Screen).

Composition modulables de bureaux en verre transparent ou "grigio Italia" fumé trempé de 12 mms d'épaisseur. Sur demande aussi en verre verni dans les coloris de nos échantillons dans la version brillante ou satinée. Piètement en chêne naturel brossé, teinté wengé, laqué blanc ou noir pores ouverts. Parties métalliques en acier inox brillant. Le "double chevalet", qui permet de joindre plus modules, est préparé pour le passage de câbles et équipé avec une bande de couverture en feutre, simili cuir ou tissu dans les coloris de nos échantillons. Il permet d'insérer les accessoires suivantes (WGS Shelf, WGS Glove, WGS Tolomeo, WGS Bar Tray et WGS Screen).

Schreibtischezusammensetzung in modularer Weise: Glasplatte vorgepannt klar oder Rauchglas "grigio Italia" 12 mm. Glas lieferbar auch lackiert nach Musterkarte. Lackierung jeweils hochglanz oder matt satiniert. Gestell Eiche natur gebrüstet, Wengé gebeizt, weiss oder schwarz lackiert offenporig. Metallteile Edelstahl (Inox) poliert. Mit dem "Doppelreiter" poliert. Mit dem "Doppelreiter" poliert und mit einem Bezugstreifen in Filz, Spaltleder oder Stoff nach Musterkarte verwendet, kann mehrere Module verbunden werden und kann die folgende Ergänzungsstücke zugesetzt werden (WGS Shelf, WGS Glove, WGS Tolomeo, WGS Bar Tray und WGS Screen).

> Composizione di scrivanie con piano in cristallo trasparente extralight da 460x140x73h cm (due da 160x140 e uno da 140x140 cm) e base in rovere spazzolato naturale. WGS Screen in feltro natural. Sedie OFX 09 h85 cm in ecopelle bianca. Composizioni Air Up Shelf in cristallo retroverniciato cemento brillante. WGS Stool in tessuto Clivia.

Composition of desks with extralight transparent glass top 460x140 x73h cm (two of 160x140 cm and one 140x140 cm) and brushed natural oak base. WGS Screen in natural felt. Chairs OFX 09 h85 cm in white eco-leather. Air Up Shelf compositions in bright cement painted glass. WGS Stool in Clivia fabric.

Composition de bureaux avec plateau en verre transparent extralight de 460x140x73h cm (deux de 160x140 cm et un 140x140cm) et piètement en chêne naturel brossé. WGS Screen en feutre naturel. Chaises OFX 09 h85 cm en simili cuir blanc. Compositions Air Up Shelf recouvertes de verre verni ciment brillant. WGS Stool en tissu Clivia.

Schreibtischezusammensetzung: Glasplatte klar extralight 460x140x73h cm (zwei 160x140 cm und einer 140x140cm). Gestell Eiche natur gebrüstet. WGS Screen in Filz natural. Stühle OFX 09 h85 cm Spaltleder weiss. Kompositionen Air Up Shelf mit Zement hochglänzendem Glas umkleidet. WGS Stool in Clivia Stoff.

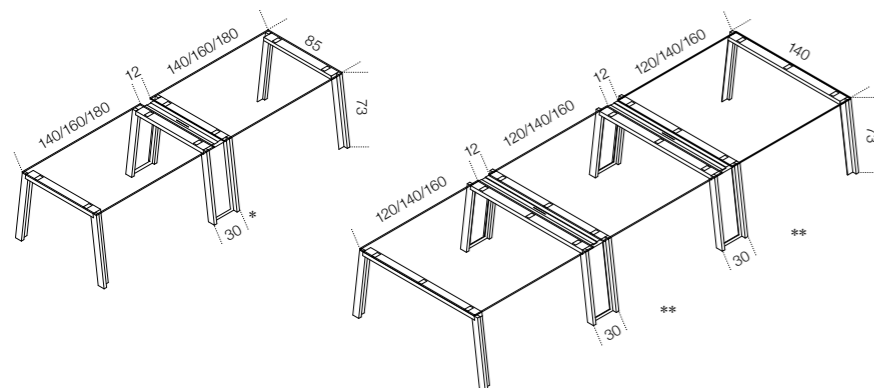
**Cm (L x P x H)**

30 x 85 x 73  
30 x 140 x 73  
140 x 85 x 73  
160 x 85 x 73  
180 x 85 x 73  
120 x 140 x 73  
140 x 140 x 73  
160 x 140 x 73

**Inches (W x D x H)**

12" x 33 3/4" x 28 3/4"  
12" x 55 3/4" x 28 3/4"  
55 1/4" x 33 3/2" x 28 3/4"  
63" x 33 3/2" x 28 3/4"  
71" x 33 3/2" x 28 3/4"  
47 1/4" x 55 1/4" x 28 3/4"  
55 1/4" x 55 1/4" x 28 3/4"  
63" x 55 1/4" x 28 3/4"





**WGS Plus**

Scrivania con piano in cristallo trasparente o "grigio Italia" temperato 12 mm. A richiesta retroverniciato nei colori del campionario nella versione brillante o satinata. Base in rovere spazzolato naturale, tinto wengé, laccato bianco o nero a poro aperto. Parti metalliche in acciaio inox lucido. Il "cavalletto doppio" è predisposto per il passaggio dei cavi e dotato di una fascia di chiusura in feltro, ecopelle o tessuto nei colori del campionario. Si presta per l'inserimento degli accessori (WGS Shelf, WGS Glove, WGS Tolomeo, WGS Bar Tray e WGS Screen).

Desk with 12 mm transparent or smoked "grigio Italia" tempered glass top. Painted glass as per sample in the bright or satin version, on request. Brushed natural oak, wengé stained, white or black open pore lacquered base. Bright stainless steel metal parts. The "double leg", suitable for cable runway and supplied with cover band made in felt, eco-leather or fabric as per samples, allows insertion of accessories (WGS Shelf, WGS Glove, WGS Tolomeo, WGS Bar Tray e WGS Screen).

Bureau avec plateau en verre transparent ou "grigio Italia" fumé trempé de 12 mms d'épaisseur. Sur demande aussi en verre verni dans les coloris de nos échantillons dans la version brillante ou satinée. Piètement en chêne naturel brossé, teinté wengé, laqué blanc ou noir pores ouverts. Parties métalliques en acier inox brillant. Le "double chevalet" est préparé pour le passage de câbles et équipé avec une bande de couverture en feutre, simili cuir ou tissu dans les coloris de nos échantillons. Il permet d'insérer les accessoires suivantes (WGS Shelf, WGS Glove, WGS Tolomeo, WGS Bar Tray e WGS Screen).

Schreibtisch: Glasplatte vorgespannt klar oder Rauchglas "grigio Italia" 12 mm. Glas lieferbar auch lackiert nach Musterkarte. Lackierung jeweils hochglanz oder matt satiniert. Gestell Eiche natur gebürstet, Wengé gebeizt, weiss oder schwarz lackiert offenporig. Metallteile Edelstahl (Inox) poliert. Mit dem "Doppelreiter", zum Kabeldurchlass und mit einem Bezugstreifen in Filz, Spaltleder oder Stoff nach Musterkarte verwendet, kann die folgende Ergänzungsteile zugesetzt werden (WGS Shelf, WGS Glove, WGS Tolomeo, WGS Bar Tray e WGS Screen).

> Scrivania con piano in cristallo retroverniciato grigio umbro brillante e base in rovere spazzolato naturale. 161x140x73h cm. Piastra in acciaio inox per alloggiamento lampada Tolomeo di Artemide. WGS Accessory Bar in acciaio inox lucido con vaschetta WGS Bar Tray. Sedie OFX 09 h85 cm in pelle scamosciata Grey 074. Composition Air Up da 242x51x48h cm rivestita in cristallo retroverniciato cemento satinato.

Desk with bright dark grey painted glass top and brushed natural oak base. 161x140x73h cm. Stainless steel plate equipped for Tolomeo table lamp of Artemide. WGS Accessory Bar in stainless steel with box WGS Bar Tray. Chairs OFX 09 h85 cm in suede Grey 074. Air Up composition 242x51x48h cm covered by satin cement painted glass.

Bureau avec plateau en verre verni gris foncé brillant et piètement en chêne naturel brossé. 161x140x73h cm Plaque en acier inox qui permet de fixer la lampe de bureau Tolomeo de Artemide. WGS Accessory Bar en acier inox brillant avec boîte WGS Bar Tray. Chaises OFX 09 h85 cm en suédine Grey 074. Composition Air Up 242x51x48h cm recouvert de verre verni ciment satiné.

Schreibtisch mit dunkel grau hochglänzender Glasplatte und Gestell Eiche natur gebürstet. 161x140x73h cm Metallplatte Edelstahl (Inox) wird zur Befestigung der Tischlampe Tolomeo von Artemide verwendet. WGS Accessory Bar Edelstahl (Inox) poliert mit Träger WGS Bar Tray. Stühle OFX 09 h85 cm Wildleder Grey 074. Composition Air Up 242x51x48h cm mit zement matt satiniertem Glas umkleidet.

**Cm (L x P x H)**

161 x 85 x 73  
181 x 85 x 73  
201 x 85 x 73  
141 x 140 x 73  
161 x 140 x 73  
181 x 140 x 73

**Inches (W x D x H)**

63½" x 33½" x 28¾"  
71½" x 33½" x 28¾"  
79¼" x 33½" x 28¾"  
55¾" x 55¼" x 28¾"  
63½" x 55¼" x 28¾"  
71½" x 55¼" x 28¾"

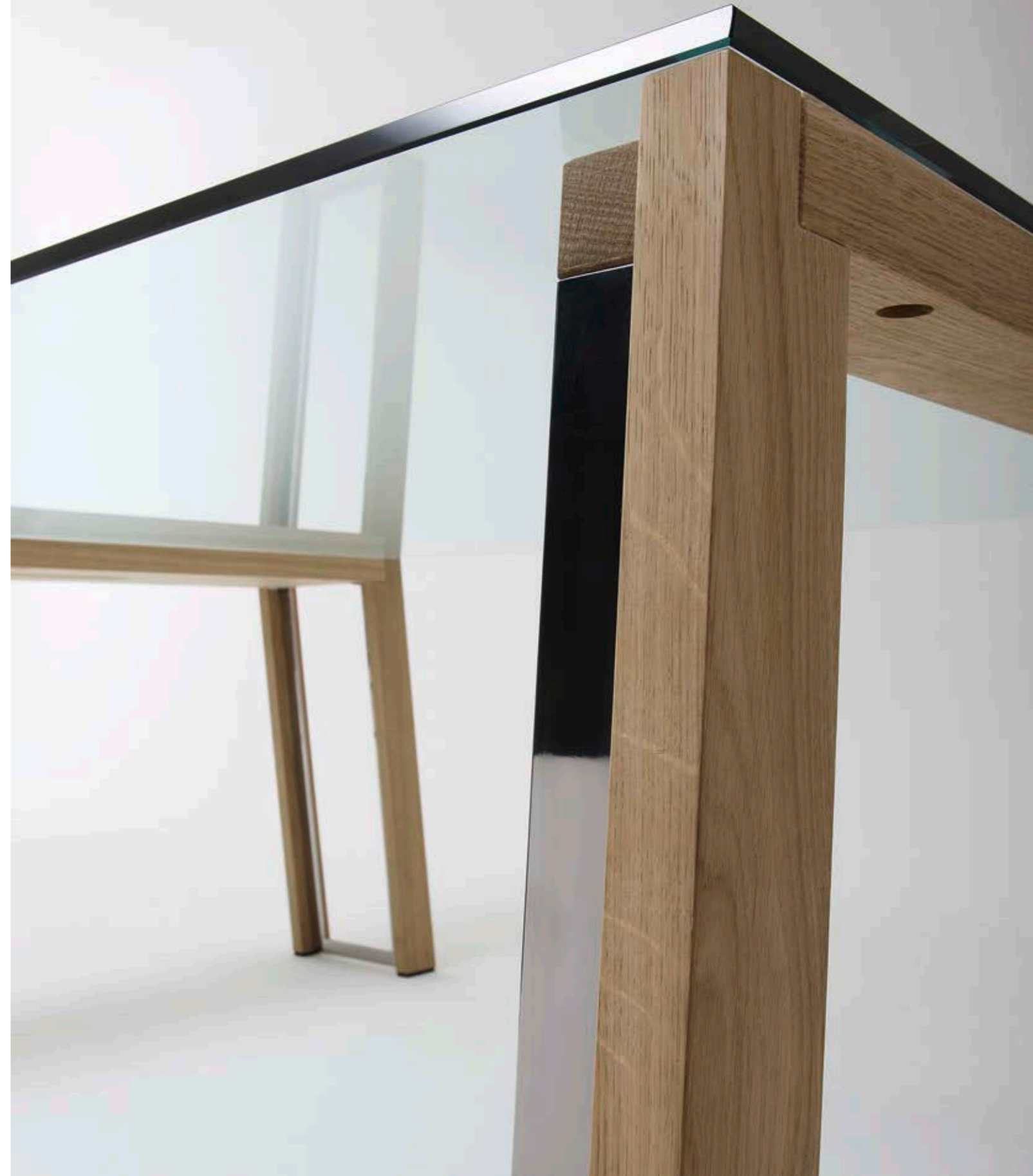
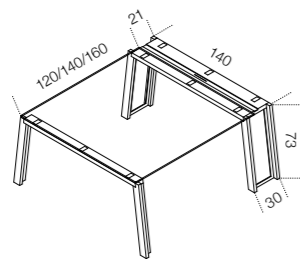
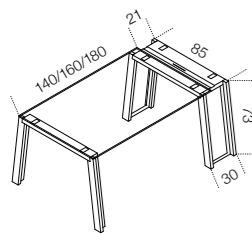



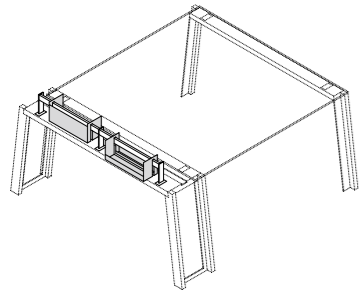

**WGS Accessory Bar**

Barra in acciaio inox lucido o satinato per scrivania terminale con "cavalletto doppio".

Vaschetta portaoggetti in metallo laccato bianco gofrato per WGS Accessory Bar.

Bright or satin stainless steel bar for a desk terminating by a with "double leg".

Embossed white lacquered metal box for WGS Accessory bar.

Barre en acier inox brillant ou satiné pour le bureau final avec "double chevalet".

Boîte porte-objet en métal laqué blanc gaufré pour WGS Accessory Bar.

Metallstab aus Edelstahl (Inox) poliert oder gebürstet für den End-Schreibtisch mit "Doppelreiter".

Metallobjektträger weiss strukturlackiert für WGS Accessory Bar.

Cm (L x P x H)		Inches (W x D x H)	
56 x 3 x 16	Bar	22 $\frac{1}{4}$ " x 1 $\frac{1}{4}$ " x 6 $\frac{1}{2}$ "	Bar
111 x 3 x 16		43 $\frac{3}{4}$ " x 1 $\frac{1}{4}$ " x 6 $\frac{1}{2}$ "	
35 x 13 x 15	Tray	14" x 5 $\frac{1}{4}$ " x 6"	Tray

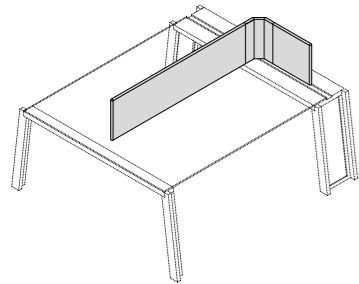
**WGS Screen**

Divisorio da tavolo in legno rivestito in feltro, ecopelle nei colori del campionario. Disponibile anche in tessuto Clivia, Corbezzolo o Narciso. Applicabile solo sul sistema modulare WGS a "cavalletto doppio" con prof. 140 cm.

Table divider in wood covered by felt, eco-leather as per samples. Available also in Clivia, Corbezzolo or Narciso fabric. It can be placed only on the modular system WGS with "double leg" cm 140 deep.

Séparateur de table en bois recouvert de feutre ou simili cuir dans les coloris de nos échantillons. Disponible aussi en tissu Clivia, Corbezzolo ou Narciso. Il peut être fixé seulement sur le système modulable WGS avec "double chevalet" prof. cm 140.

Tisch-Trennwand aus Holz mit Filz, Spaltleder bezogen. Lieferbare Farben nach Musterkarte. Auf Wunsch auch mit Stoff Clivia, Corbezzolo oder Narciso bezogen. Ausschliesslich für das Modular WGS-System "Doppelreiter" Tiefe 140 verwendbar.

Cm (L x P x H)		Inches (W x D x H)	
100 x 54 x 35		39 $\frac{1}{2}$ " x 21 $\frac{1}{2}$ " x 14"	
120 x 54 x 35		47 $\frac{1}{4}$ " x 21 $\frac{1}{2}$ " x 14"	
140 x 54 x 35		55 $\frac{1}{4}$ " x 21 $\frac{1}{2}$ " x 14"	

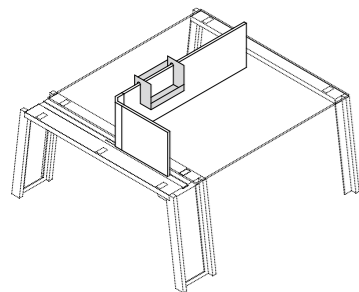
**WGS Screen Tray**

Vaschetta portaoggetti in metallo laccato bianco gofrato per WGS Screen.

Embossed white lacquered metal box for WGS Screen.

Boîte porte-objet en métal laqué blanc gaufré pour WGS Screen.

Metallobjektträger weiss strukturlackiert für WGS Screen.

Cm (L x P x H)		Inches (W x D x H)	
30 x 15 x 17		12" x 6" x 6 $\frac{3}{4}$ "	

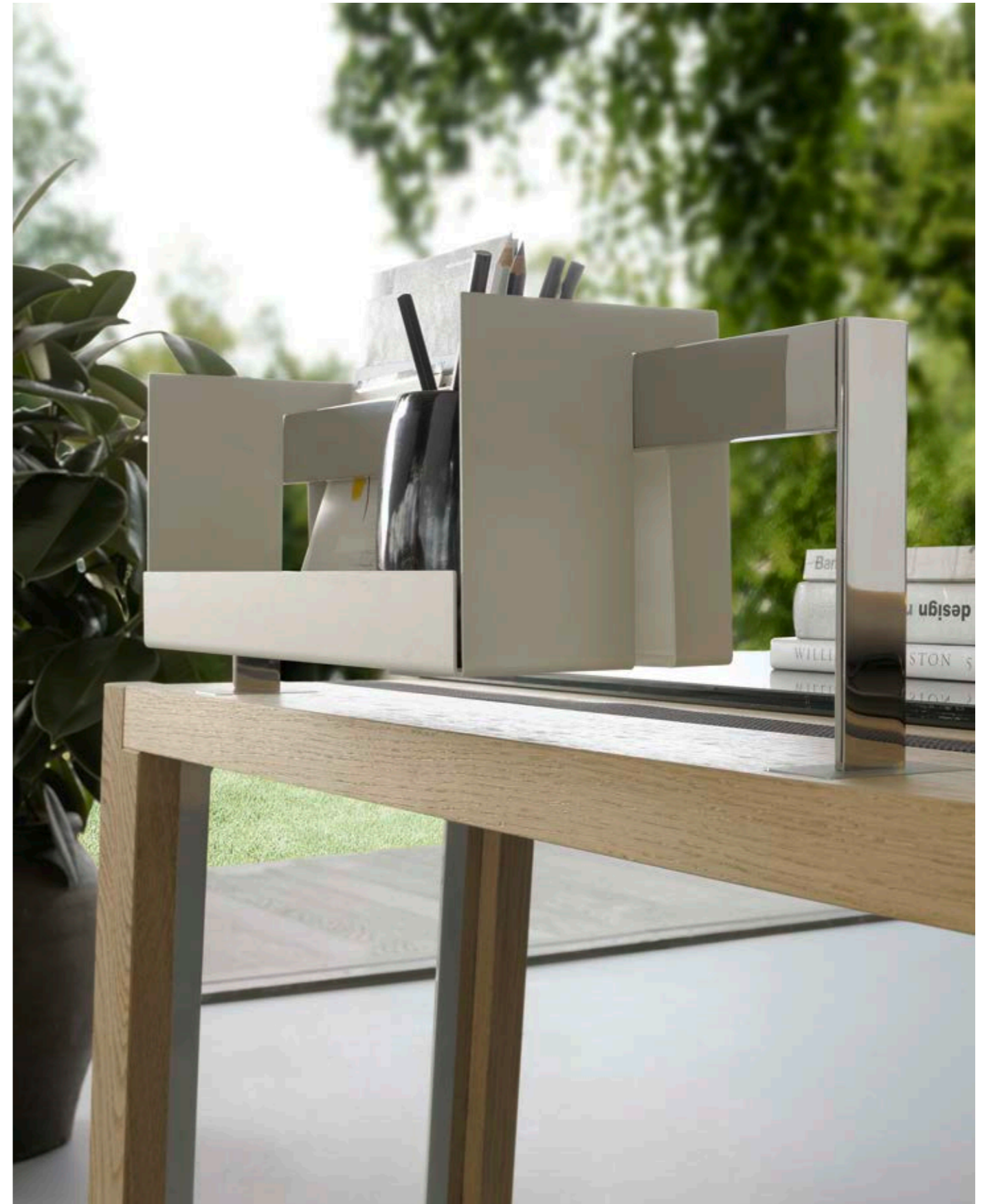

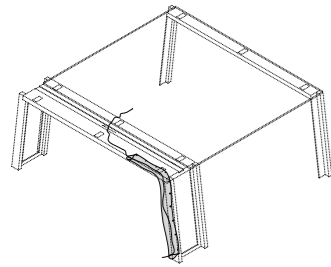
**WGS Glove**

Passacavi in feltro natural, per "cavalletto doppio" WGS. Completamente ispezionabile grazie ad un sistema di chiusura a velcro.

Felt cable management in natural colour for WGS "double leg". Totally inspectable thanks to a velcro closure system.

Sachet cache-fils en feutre naturel pour WGS "double chevalet". Complètement accessible par un système de fermeture avec velcro.

Kabelabdeckung aus Filz natural für WGS "Doppelreiter". Durch Klettverschluss ganz erreichbar.

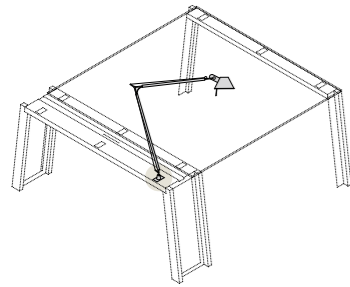
**WGS Tolomeo**

Piastra in acciaio inox predisposta per l'alloggio della lampada da tavolo Tolomeo di Artemide. Vedi a pagina 60.

Stainless steel plate equipped for Tolomeo table lamp of Artemide. See at page 60.

Plaque en acier inox qui permet de fixer la lampe de bureau Tolomeo de Artemide. Voir à la page 60.

Metallplatte aus Edelstahl (Inox) poliert wird zur Befestigung der Tischlampe Tolomeo von Artemide verwendet. Siehe auf Seite 60.

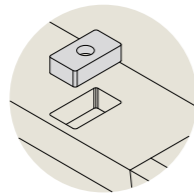
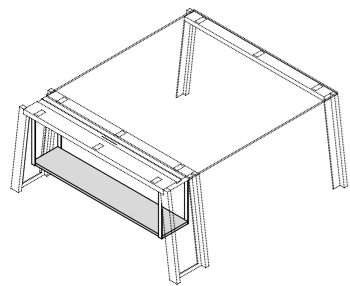
**WGS Shelf**

Mensola in legno per "cavalletto doppio" WGS. Parti metalliche in acciaio inox.

Wooden shelf for the WGS "double leg". Stainless steel metal parts.

Etagère en bois pour WGS "double chevalet". Parties métalliques en acier inox.

Ablagebord aus Holz und Edelstahl (Inox) am WGS "Doppelreiter" anzubringen. Metallteile Edelstahl (Inox) poliert.

Cm (L x P x H)

66 x 24 x 35h

121 x 24 x 35h

Inches (W x D x H)

26" x 9½" x 14"h

47¾" x 9½" x 14"h

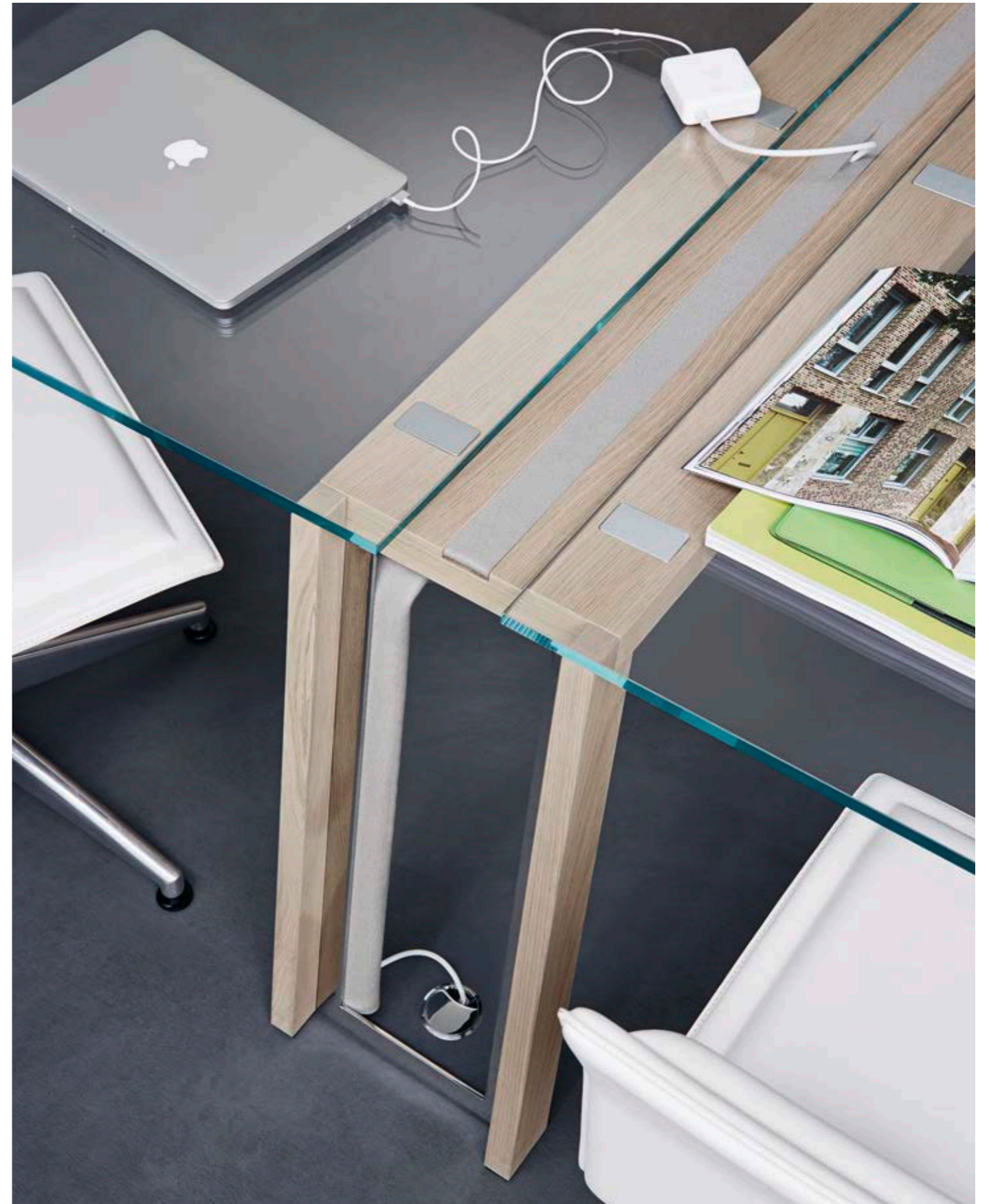

# Koy

## Koy System

Sistema modulare di scrivanie con struttura in alluminio rivestito in rovere tinto tabacco o tinto wengé. Disponibile anche laccato bianco o nero goffrato o laccato effetto tessuto nei colori castagna, sabbia e canapa. Piano in cristallo trasparente o "grigio Italia" 12 mm. Su richiesta retroverniciato nei colori del campionario nella versione brillante o satinata. La scrivania può essere dotata di sistema passacavi.

Modular system of desks with aluminium structure covered by tobacco stained or wengé stained oak. Available also with embossed white or black lacquered structure or "fabric" touch effect lacquered structure in the chestnut, sand and canapa colours. 12 mm transparent or smoked "grigio Italia" glass top. Painted glass, as per samples, in the bright or satin version, on request. Available with cable management.

Composition modulables de bureaux avec structure en aluminium recouvert de chêne teinté tabac ou teinté wengé. Disponible aussi laqué blanc ou noir gaufré ou laqué avec effet tissu dans les coloris châtaigne, sablé et chanvre. Plateau en verre transparent ou "grigio Italia" fumé de 12 mms d'épaisseur. Sur demande verni dans les coloris de nos échantillons dans la version brillante ou satinée. Sur demande disponible avec système pour le passage des câbles.

Schreibtischezusammensetzung in modularer Weise: Aluminiumgestell mit Eiche Tabakfarbe oder Wengé gebeizt umkleidet. Lieferbar auch weiss oder schwarz strukturlackiert oder lackiert mit Stoff-Effekt in kastanienbraun, sandfarben und hanffarben. Glasplatte klar oder Rauchglas "grigio Italia" 12 mm. Auf Wunsch Glas lackiert nach Musterkarte. Lackierung jeweils hochglanz oder matt satiniert. Auf Wunsch kann der Schreibtisch mit Kabeldurchlass geliefert werden.

> Composizione di scrivanie da 460x140x74h (una da 140x140 cm con piano in cristallo trasparente extralight, due da 160x140 cm con piani in cristallo retroverniciato bianco satinato) con struttura laccato bianco goffrato. Koy screen in tessuto Corbezzolo. Sedie OFX 85h cm in ecopelle bianca. Cassettiere Techna 13 bianco. Composizione Air Up da 614x51x143h cm rivestita in cristallo retroverniciato cemento satinato.

Composition of desks 460 x140x74h cm (one 140x140 cm with extralight transparent glass top and two 160x140 cm with satin white painted glass top) and embossed white lacquered base. KOY Screen in Corbezzolo fabric. Chairs OFX 09 h85 cm in white eco-leather. Drawer unit Techna 13 white. Air Up composition 614x51x143h cm in satin cement painted glass.

Composition de bureaux de 460x140x74h cm (un 140x140 cm avec plateau en verre transparent extralight et deux de 160 x140 cm avec plateau en verre verni blanc satiné) et structure laqué blanc gaufré. KOY Screen en tissu Corbezzolo. Chaises OFX 09 h85 cm en simili cuir blanc. Techna 13 bloc tiroir blanc. Composition Air Up 614x51x143h cm recouvert de verre verni ciment satiné.

Schreibtischezusammensetzung 460x140x74h cm (einer 140x140 cm mit Glasplatte klar Extralight und zwei 160x140 cm mit Glasplatte weiss matt satiniert). Gestell weiss strukturlackiert. KOY Screen aus Corbezzolo Stoff. Stühle OFX 09 h85 cm Spaltleder weiss. Komposition Air Up 614x51x143h cm mit Zement matt satiniertem Glas umkleidet.

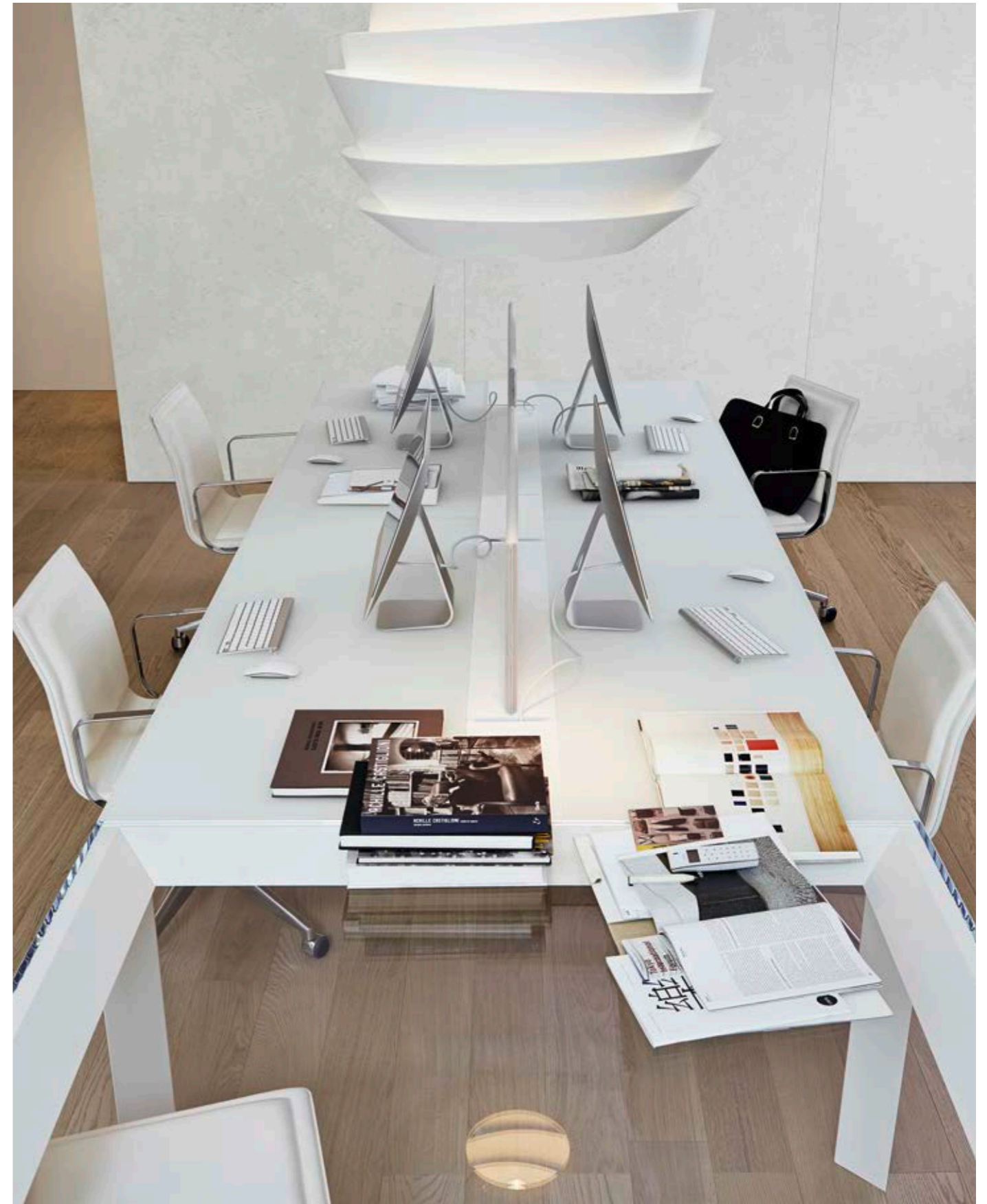



Koy

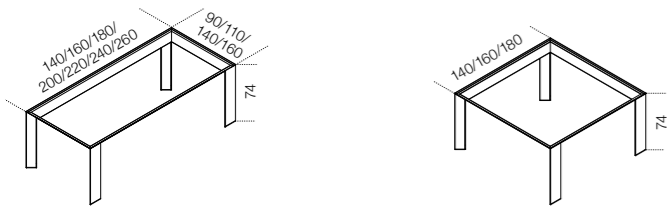

Cm (L x P x H)	Inches (W x D x H)
140 x 90 x 74	55 1/4" x 35 1/2" x 29 1/4"
160 x 90 x 74	63" x 35 1/2" x 29 1/4"
180 x 90 x 74	71" x 35 1/2" x 29 1/4"
200 x 90 x 74	78 3/4" x 35 1/2" x 29 1/4"
220 x 90 x 74	86 3/4" x 35 1/2" x 29 1/4"
140 x 110 x 74	55 1/4" x 43 1/2" x 29 1/4"
160 x 110 x 74	63" x 43 1/2" x 29 1/4"
180 x 110 x 74	71" x 43 1/2" x 29 1/4"
200 x 110 x 74	78 3/4" x 43 1/2" x 29 1/4"
220 x 110 x 74	86 3/4" x 43 1/2" x 29 1/4"
240 x 110 x 74	94 1/2" x 43 1/2" x 29 1/4"
260 x 110 x 74	102 1/2" x 43 1/2" x 29 1/4"
160 x 140 x 74	63" x 55 1/4" x 29 1/4"
180 x 140 x 74	71" x 55 1/4" x 29 1/4"
180 x 160 x 74	71" x 63" x 29 1/4"
140 x 140 x 74	55 1/4" x 55 1/4" x 29 1/4"
160 x 160 x 74	63" x 63" x 29 1/4"
180 x 180 x 74	71" x 71" x 29 1/4"

Koy System

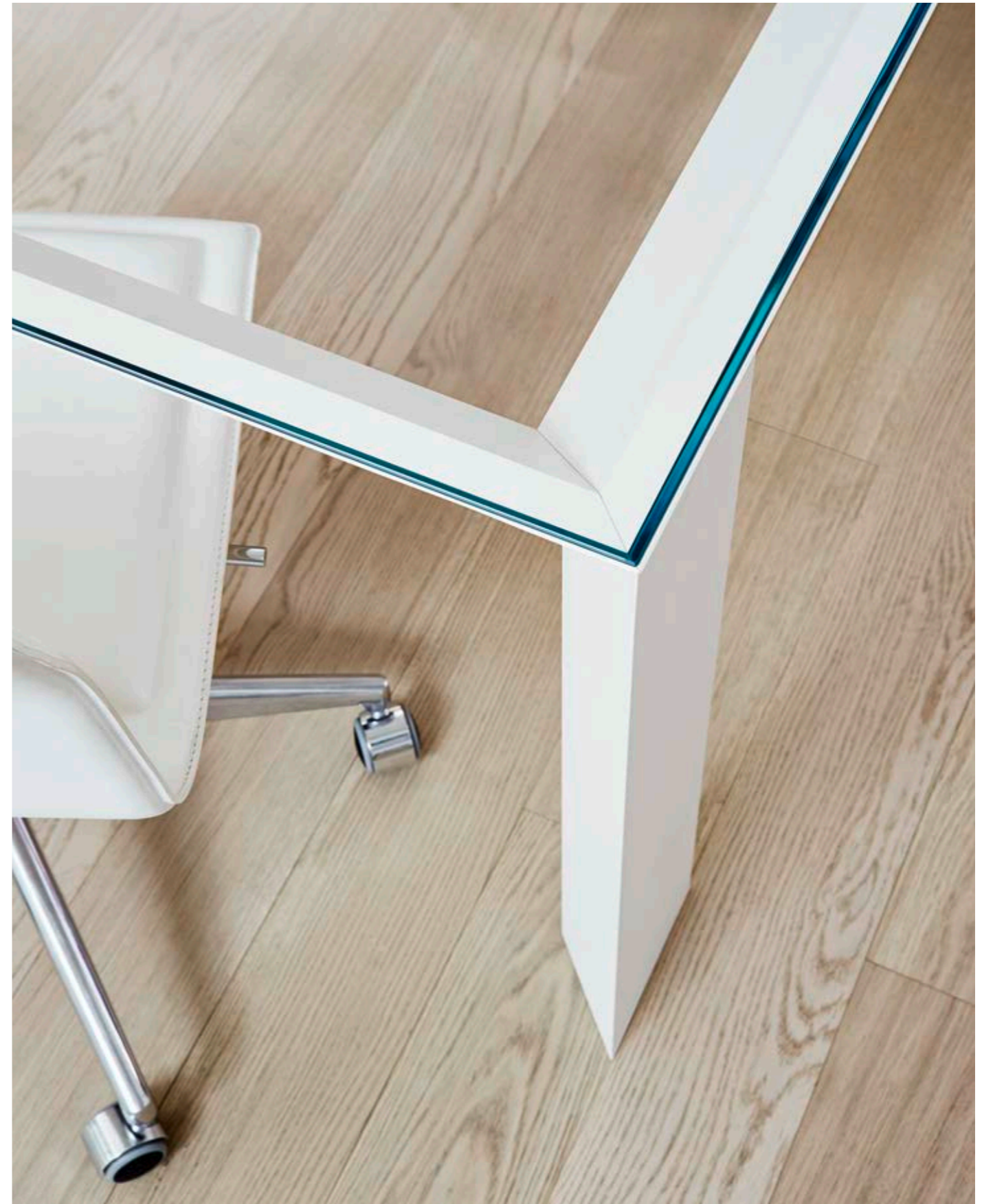
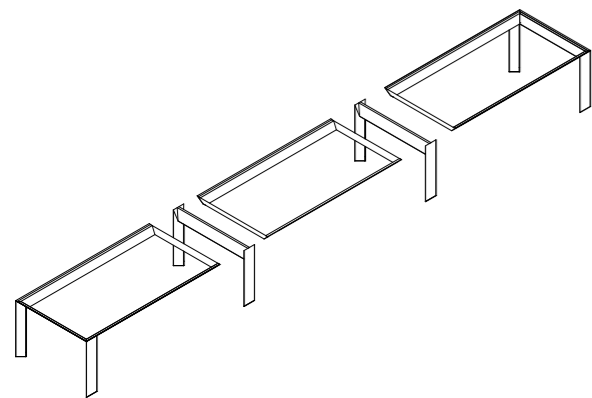
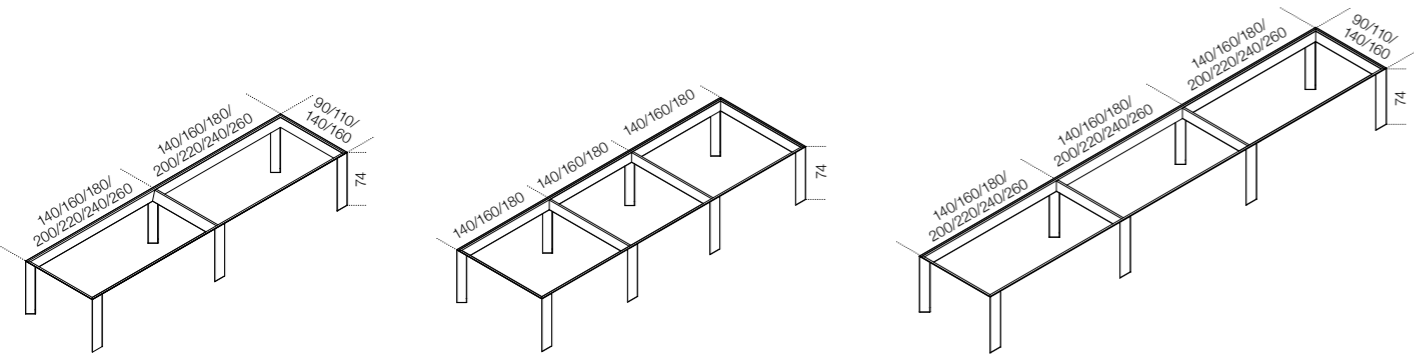

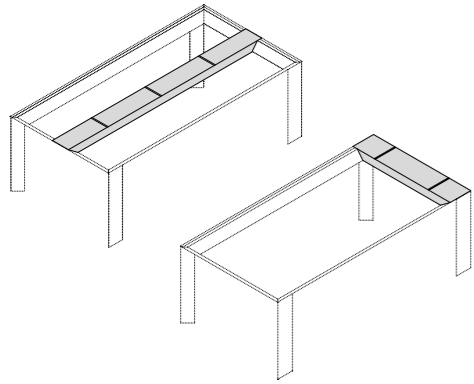
**Koy Cable**

Sistema di passacavi con vano ispezionabile e piani removibili in legno nello stesso colore della struttura.

Cable management system with an inspectable unit. Removable wooden shelves in the same colour of the structure.

Système pour le passage des câbles avec un espace accessible et des tablettes amovibles en bois dans le même couleur de la structure.

Kabelkanal ausgestattet werden, der über, in den gleichen Tischfarben, eingesetzte Holzböden zugänglich ist.

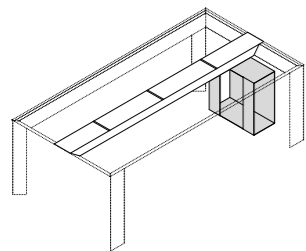
**Koy Tower**

Elemento portatower in lamiera metallica verniciata bianco o nero goffrato da fissare al Koy System con sistema passacavi centrale.

Computer case holder in embossed white or black lacquered metal to be fixed to Koy System with central cable management.

Porte-tower en tôle métallique vernie blanc ou noir gaufré à fixer sous les bureaux du Koy System avec système pour le passage des câbles central.

Computer-case-möbel aus Metall weiss oder schwarz strukturlackiert unter dem Koy System mit Kabeldurchlass in der Mitte zu befestigen.

Cm (L x P x H)

50 x 23 x 50  
100 x 23 x 50

Inches (W x D x H)

19 $\frac{3}{4}$ " x 9 $\frac{1}{4}$ " x 19 $\frac{3}{4}$ "  
39 $\frac{1}{2}$ " x 9 $\frac{1}{4}$ " x 19 $\frac{3}{4}$ "

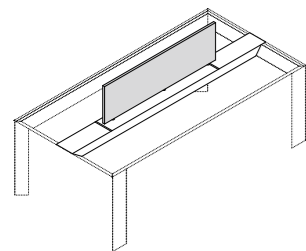
**Koy Screen**

Divisorio da tavolo in legno rivestito in feltro nei colori del campionario. Disponibile anche in tessuto Clivia, Corbezzolo o Narciso. Applicabile solo sul sistema modulare Koy System con profondità cm 140/160/180.

Table divider in wood covered by felt as per samples. Available also in Clivia, Corbezzolo or Narciso fabric. It can be placed only on the modular system Koy System with cm 140/160/180 deep.

Séparateur de table en bois recouvert de feutre dans les coloris de nos échantillons. Disponible aussi en tissu Clivia, Corbezzolo ou Narciso. Il peut être fixé seulement sur le système modulable Koy System avec prof. cm 140/160/180.

Tisch-Trennwand aus Holz mit Filz bezogen. Lieferbare Farben nach Musterkarte. Auf Wunsch auch mit Stoff Clivia, Corbezzolo oder Narciso bezogen. Ausschliesslich für das Modular-Koy-System Tiefe 140/160/180 verwendbar.

Cm (L x P x H)

100 x 2 x 37  
120 x 2 x 37

Inches (W x D x H)

39 $\frac{1}{2}$ " x 1" x 14 $\frac{3}{4}$ "  
47 $\frac{1}{4}$ " x 1" x 14 $\frac{3}{4}$ "

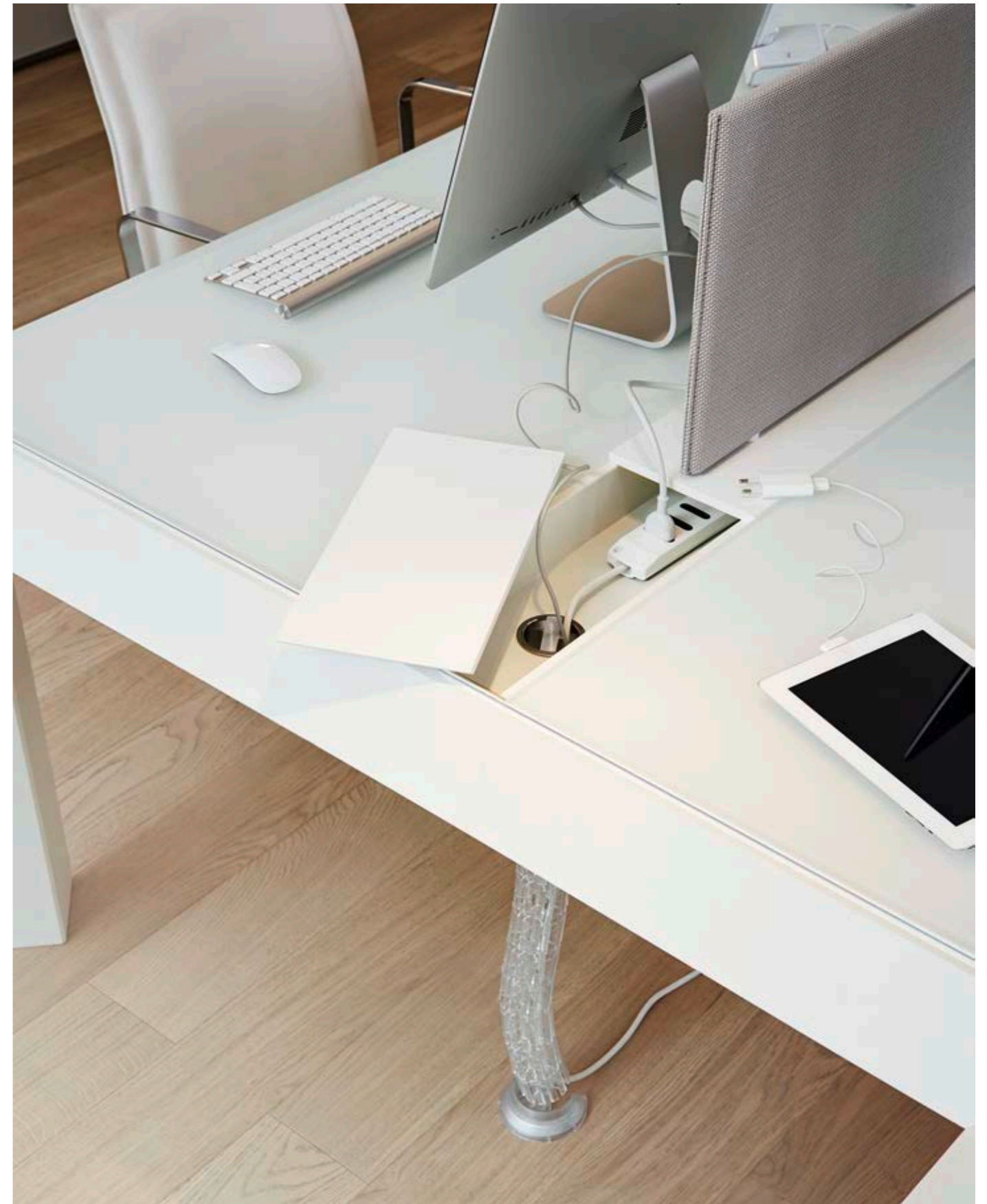

# President

## President Scrivania

Scrivania in cristallo trasparente temperato. Parti metalliche in acciaio inox lucido. A richiesta acciaio inox satinato, ottone protetto o laccato bianco o nero goffrato. Per consentire il passaggio dei cavi è possibile richiedere una foratura nel piano. Distanza minima dal bordo: 10 cm.

Desk in transparent tempered glass. Bright stainless steel metal parts. Satin stainless steel, protected brass or embossed white or black lacquered metal parts, on request. For a proper cable management, a hole on the top can be arranged upon request. Minimum distance from the edge: 10 cm.

Bureau en verre transparent trempé. Parties métalliques en acier inox brillant. Sur demande acier inox satiné, laiton protégé ou laqué blanc ou noir gaufré. Pour permettre le passage des câbles un trou peut être réalisé dans le plateau. Distance minimum du bord: 10 cm.

Schreibtisch: vorgespanntes Glas klar. Metallteile Edelstahl (Inox) poliert. Auf Wunsch Edelstahl (Inox) gebürstet, Messing zaponiert oder weiss oder schwarz strukturlackiert. Kabel können durch eine zu bestellende Bohrung in der Platte geführt werden. Mindestabstand von der Kante: 10 cm.

## President Dattilo

Dattilo in cristallo trasparente temperato 10 mm. Parti metalliche in acciaio inox lucido. A richiesta acciaio inox satinato, ottone protetto o laccato bianco o nero goffrato. Per consentire il passaggio dei cavi è possibile richiedere una foratura nel piano. Distanza minima dal bordo: 10 cm.

Return in 10 mm transparent tempered glass. Bright stainless steel metal parts. Satin stainless steel, protected brass or embossed white or black lacquered metal parts, on request. For a proper cable management, a hole on the top can be arranged upon request. Minimum distance from the edge: 10 cm.

Retour en verre transparent trempé de 10 mms d'épaisseur. Parties métalliques en acier inox brillant. Sur demande acier inox satiné, laiton protégé ou laqué blanc ou noir gaufré. Pour permettre le passage des câbles un trou peut être réalisé dans le plateau. Distance minimum du bord: 10 cm.

Schreibtisch: vorgespanntes Glas klar 10 mm. Metallteile Edelstahl (Inox) poliert. Auf Wunsch Edelstahl (Inox) gebürstet, Messing zaponiert oder weiss oder schwarz strukturlackiert. Kabel können durch eine zu bestellende Bohrung in der Platte geführt werden. Mindestabstand von der Kante: 10 cm.

> Dattilo in cristallo trasparente extralight e parti metalliche in acciaio inox lucido.

Extralight transparent glass return and bright stainless steel metal parts.

Retour en verre transparent extralight et parties métalliques en acier inox brillant.

Schreibtisch Glas klar Extralight und Metallteile aus Edelstahl (Inox) poliert.

>> Scrivania in cristallo trasparente extralight da 180x85x74h cm e parti metalliche in acciaio inox lucido. Dattilo in cristallo trasparente extralight e parti metalliche in acciaio inox lucido. Sedie OFX 09 85h cm in pelle scamosciata Grey 074. Composizione Air Up da 121,5x51x143h cm rivestita in cristallo retroverniciato cemento satinato.

Extralight transparent glass desk 180x85x74h cm and bright stainless steel metal parts. Extralight transparent glass return and bright stainless steel metal parts. Chairs OFX 09 85h cm in suede Grey 074. Air Up composition 121,5x51x143h cm covered by satin cement painted glass.

Bureau en verre transparent extralight de 180x85x74h cm et parties métalliques en acier inox brillant. Retour en verre transparent extralight et parties métalliques en acier inox brillant. Chaises OFX 09 85h cm en suédine Grey 074. Composition Air Up 121,5x51x143h cm recouverte de verre verni ciment satiné.

Schreibtisch Glas klar Extralight 180x85x74h cm und Metallteile aus Edelstahl (Inox) poliert. Schreibtisch Glas Extralight und Metallteile aus Edelstahl (Inox) poliert. Stühle OFX 09 Wildleder Grey 074. Komposition Air Up 121,5x51x143h cm mit zement matt satiniertem Glas umkleidet.

President Scrivania

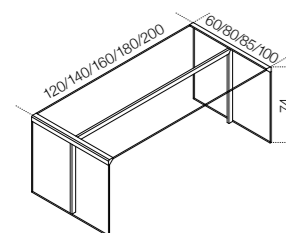

President Dattilo

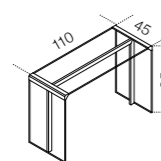

Glass	mm	Inches	Cm (L x P x H)	Inches (W x D x H)
	10	4"	110 x 45 x 65	43½" x 17¾" x 25¾"
	10	4"	120 x 60 x 74	47¼" x 23¾" x 29¼"
	10	4"	140 x 60 x 74	55½" x 23¾" x 29¼"
	10	4"	160 x 80 x 74	63" x 31½" x 29¼"
	12	4¾"	180 x 85 x 74	71" x 33½" x 29¼"
	12	4¾"	200 x 100 x 74	78¾" x 39½" x 29¼"







**President Senior / President Junior**

Scrivania in cristallo trasparente temperato. Parti metalliche in acciaio inox lucido. A richiesta acciaio inox satinato, ottone protetto o laccato bianco o nero goffrato. Per consentire il passaggio dei cavi è possibile richiedere una foratura nel piano. Distanza minima dal bordo: 10 cm.

Desk in transparent tempered glass. Bright stainless steel metal parts. Satin stainless steel, protected brass or embossed white or black lacquered metal parts, on request. For a proper cable management, a hole on the top can be arranged upon request. Minimum distance from the edge: 10 cm.

Bureau en verre transparent trempé. Parties métalliques en acier inox brillant. Sur demande acier inox satiné, laiton protégé ou laqué blanc ou noir gaufré. Pour permettre le passage des câbles un trou peut être réalisé dans le plateau. Distance minimum du bord: 10 cm.

Schreibtisch: vorgespanntes Glas klar. Metallteile Edelstahl (Inox) poliert. Auf Wunsch Edelstahl (Inox) gebürstet, Messing zaponiert oder weiss oder schwarz strukturlackiert. Kabel können durch eine zu bestellende Bohrung in der Platte geführt werden. Mindestabstand von der Kante: 10cm.

> Scrivania in cristallo trasparente extralight e parti metalliche in acciaio inox satinato. Sedia OFX 09 h85 cm in ecopelle bianca. WGS Stool in acciaio inox rivestiti in tessuto outdoor Corbezzolo e Narciso.

Extralight transparent glass desk and satin stainless steel metal parts. Chair OFX 09 h85 cm in white eco-leather. WGS Stool in stainless steel covered by Corbezzolo and Narciso outdoor fabric.

Bureau en verre transparent extralight et parties métalliques en acier inox satiné. Chaise OFX 09 h85 cm en simili cuir blanc. WGS Stool tabouret en acier inox recouvert de tissu pour outdoor Corbezzolo et Narciso.

Schreibtisch Glas klar Extralight und Metallteile aus Edelstahl (Inox) gebürstet. Stuhl OFX 09 h85 cm Spaltleder weiss. WGS Stool Hocker aus Edelstahl (Inox) mit Corbezzolo und Narciso Outdoor-Stoff bezogen.

President Senior

President Junior

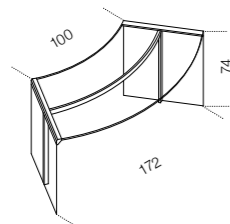
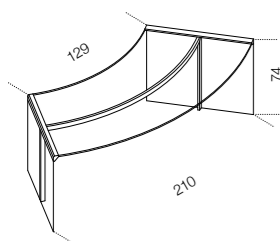
Senior  
Junior

Cm (L x P x H)

210 x 106 x 74

172 x 80 x 74

Inches (W x D x H)

82¾" x 41¾" x 29¼"

67¾" x 31½" x 29¼"



# Quadra

Scrivania con piano in cristallo trasparente 12 mm. A richiesta retroverniciato nei colori del campionario, nella versione brillante o satinata. Struttura in acciaio inox lucido o satinato. Disponibile con cassetiera in legno laccato grigio umbro, bianco o nero poro chiuso. Dotata di 4 cassetti con estrazione totale e vano a giorno. Per consentire il passaggio dei cavi è possibile richiedere una foratura nel piano. Distanza minima dal bordo: 10 cm.

Desk with 12 mm transparent glass top. Painted glass as per samples in the bright or satin version on request. Structure in bright or satin stainless steel. Available with drawer unit in dark grey lacquered wood. Alternatively in white or black lacquered wood closed pore. 4 pull-out drawers. Open unit with glass shelf. For a proper cable management, a hole on the top can be arranged upon request. Minimum distance from the edge: 10 cm.

Bureau avec plateau en verre transparent de 12 mms d'épaisseur. Sur demande en verre verni dans les coloris de nos échantillons dans la version brillante ou satinée. Structure en acier inox brillant ou satiné. Disponible avec caisson en bois laqué gris foncé, blanc ou noir pore fermé. 4 tiroirs complètement extractibles. Arrière ouvert avec tablette en verre. Pour permettre le passage des câbles un trou peut être réalisé dans le plateau. Distance minimum du bord: 10 cm.

Schreibtisch: Glasplatte klar 12 mm. Lieferbar auch lackiert nach Musterkarte. Lackierung jeweils hochglanz oder matt satiniert. Gestell Edelstahl (Inox) poliert oder gebürstet. Lieferbar mit Rollcontainer 4 Schubladen Holz dunkelgrau, weiss oder schwarz decklackiert. Schublade mit Vollauszug. Rückseite offen mit Glasboden. Kabel können durch eine zu bestellende Bohrung in der Platte geführt werden. Mindestabstand von der Kante: 10 cm.

> Scrivania con piano in cristallo retroverniciato nero satinato da 160x72 cm. Parti metalliche in acciaio inox lucido.

Desk with satin black painted glass top 160x72 cm. Bright stainless steel metal parts.

Bureau avec plateau en verre verni noir satiné de 160x72 cm. Parties métalliques en acier inox brillant.

Schreibtisch mit schwarz matt satiniertes Glasplatte von 160x72 cm. Metallteile Edelstahl (Inox) poliert.



> Scrivania con piano in cristallo retroverniciato nero satinato da 160x72 cm. Cassettiera in legno nero. Parti metalliche in acciaio inox lucido.

Desk with satin black painted glass top 160x72 cm. Black wooden drawer unit. Bright stainless steel metal parts.

Bureau avec plateau en verre verni noir satiné de 160x72 cm. Bloc tiroir en bois laqué noir. Parties métalliques en acier inox brillant.

Schreibtisch mit schwarz matt satiniertes Glasplatte von 160x72 cm. Schubladenelement Holz schwarz lackiert. Metallteile Edelstahl (Inox) poliert.

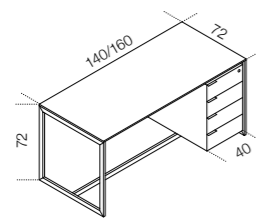
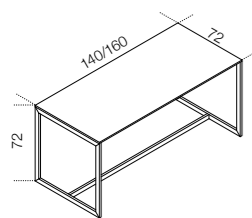

Cm (L x P x H)  
140 x 72 x 74  
160 x 72 x 74

Inches (W x D x H)  
55¼" x 28½" x 29¼"  
63" x 28½" x 29¼"

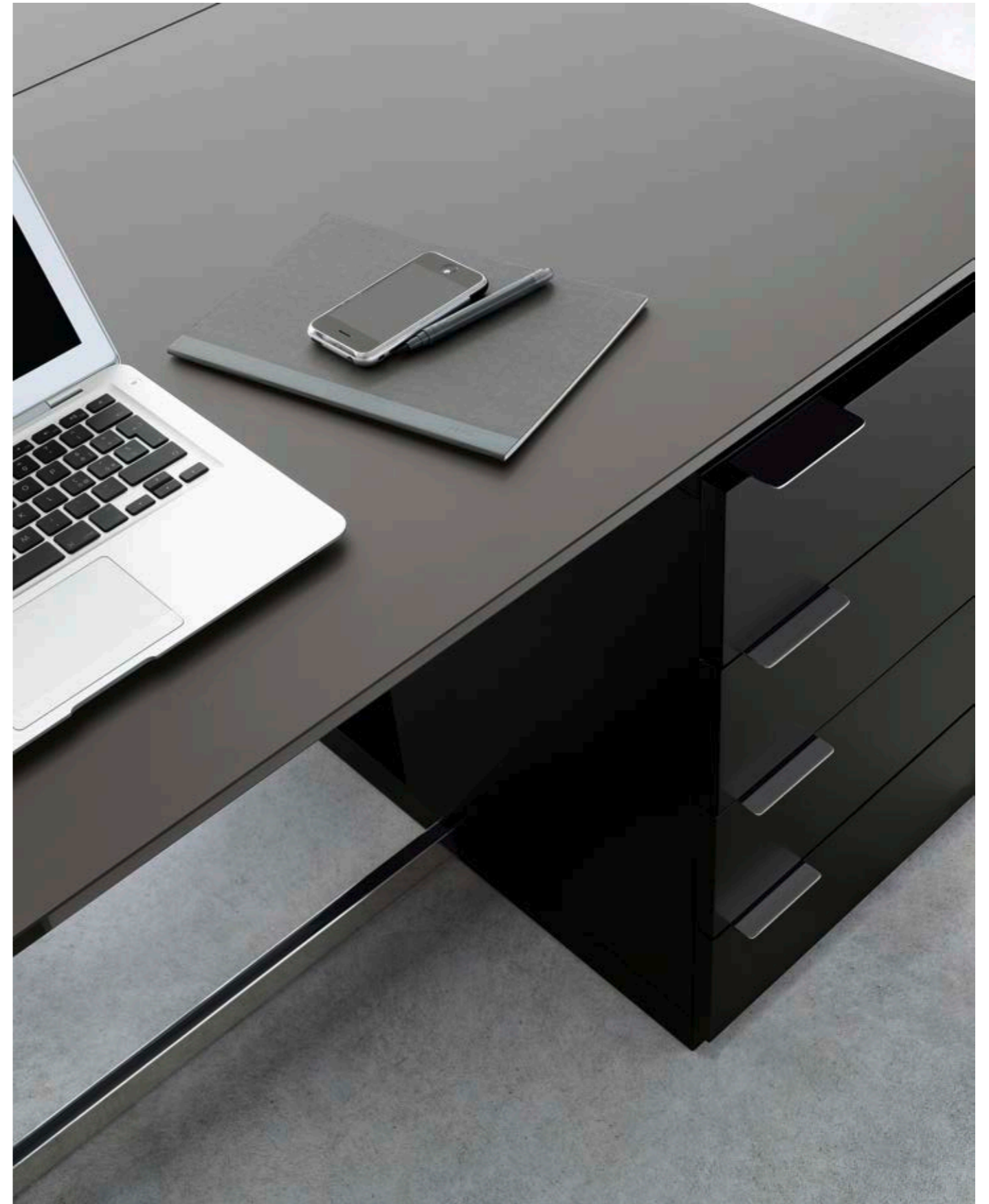

# Smart

Scrivania con struttura in acciaio inox lucido. Su richiesta anche in acciaio inox satinato. Piano in cristallo 12 mm temperato retroverniciato nei colori del campionario nella versione brillante o satinata e telaio in acciaio inox. Per consentire il passaggio dei cavi è possibile richiedere una foratura nel piano. Distanza minima dal bordo: 10 cm.

Desk with bright stainless steel structure. Available also satin stainless steel. 12 mm tempered painted glass top as per samples, in the bright or satin version. Stainless steel top frame. For a proper cable management, a hole on the top can be arranged upon request. Minimum distance from the edge: 10 cm.

Bureau avec structure en acier inox brillant. Sur demande aussi en acier inox satiné. Plateau en verre de 12 mms d'épaisseur verni dans les coloris de nos échantillons dans la version brillante ou satiné. Cadre en acier inox. Pour permettre le passage des câbles un trou peut être réalisé dans le plateau. Distance minimum du bord: 10 cm.

Schreibtisch: Gestell Edelstahl (Inox) poliert. Auf Wunsch auch Edelstahl (Inox) gebürstet. Glasplatte 12 mm vorge-spannt lackiert nach Musterkarte. Lackierung jeweils hochglanz oder matt satiniert. Bodenrahmen Edelstahl (Inox). Kabel können durch eine zu bestellende Bohrung in der Platte geführt werden. Mindestabstand von der Kante: 10 cm.

>> Scrivanie con piano in cristallo retroverniciato cemento satinato da 180 x90 cm e parti metalliche in acciaio inox lucido. Sedie OFX 09 h85 cm in ecopelle bianca. Cassetiera Air Drawer rivestita in cristallo retroverniciato cemento brillante. Mobili Tot in legno laccato effetto tessuto color canapa e cristallo retroverniciato cemento satinato con ripiani in cristallo trasparente extralight.

Desks with satin cement painted glass top 180x90 cm and bright stainless steel metal parts. Chairs OFX09 h85 cm in white eco-leather. Air Drawer drawer unit covered by bright cement painted glass. Tot storage units in canapa lacquered wood with "fabric" touch effect and satin cement painted glass with extralight transparent glass shelves.

Bureaux avec plateau en verre verni ciment satiné de 180x90 cm et parties métalliques en acier inox brillant. Chaises OFX 09 h85 cm en simili cuir blanc. Air Drawer bloc tiroir recouvert de verre verni ciment brillant. Tot meubles en bois laqué chanvre avec effet tissu et verre verni ciment satiné et tablettes en verre transparent extralight.

Schreibtische mit zement matt satiniertes Glasplatte von 180x90 cm. Metallteile Edelstahl (Inox) poliert. Stühle OFX 09 h85 cm Spaltleder weiss. Air Drawer Rollcontainer mit zement hochglänzendem Glas umkleidet. Tot Möbel Holz hanffarben lackiert mit Stoff-Effekt und Glas zement matt satiniert. Böden aus Glas klar Extralight.

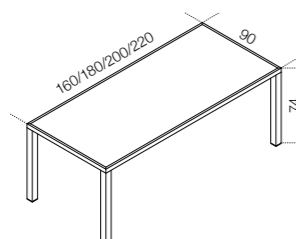
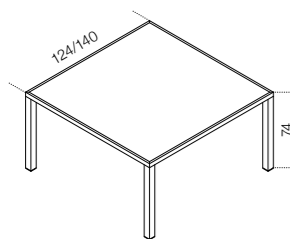

Cm (L x P x H)	Inches (W x D x H)
124 x 124 x 74	49" x 49" x 29 1/4"
140 x 140 x 74	55 1/4" x 55 1/4" x 29 1/4"
160 x 90 x 74	63" x 35 1/2" x 29 1/4"
180 x 90 x 74	71" x 35 1/2" x 29 1/4"
200 x 90 x 74	78 3/4" x 35 1/2" x 29 1/4"
220 x 90 x 74	86 3/4" x 35 1/2" x 29 1/4"





# Smart Hall

Scrivania per reception con struttura in acciaio inox lucido. Su richiesta anche in acciaio inox satinato. Piano in cristallo 12 mm retroverniciato nei colori del campionario nella versione brillante o satinata e telaio in acciaio inox di sezione 40x20x2 mm. Pannellatura in cristallo retroverniciato. Per consentire il passaggio dei cavi è possibile richiedere una foratura nel piano. Distanza minima dal bordo: 10 cm.

Reception desk with bright stainless steel structure. Available also in satin stainless steel. 12 mm painted glass top as per samples, in the bright or satin version. Stainless steel top frame 40x20x2 mm. Painted glass panel. For a proper cable management, a hole on the top can be arranged upon request. Minimum distance from the edge: 10 cm.

Bureau pour la réception avec structure en acier inox brillant. Sur demande aussi en acier inox satiné. Plateau en verre de 12 mms d'épaisseur verni dans les coloris de nos échantillons dans la version brillante ou satinée. Cadre en acier inox 40x20x2 mm. Panneau en verre verni. Pour permettre le passage des câbles un trou peut être réalisé dans le plateau. Distance minimum du bord: 10 cm.

Empfangsschreibtisch. Gestell Edelstahl (Inox) poliert. Auf Wunsch Edelstahl (Inox) gebürstet. Glasplatte 12 mm lackiert nach Musterkarte. Lackierung jeweils hochglanz oder matt satiniert. Gestellprofil Edelstahl 40x20x2 mm. Paneel Glas lackiert. Kabel können durch eine zu bestellende Bohrung in der Platte geführt werden. Mindestabstand von der Kante: 10 cm.

> Scrivania per reception in cristallo retroverniciato nero satinato da 200x90x74h/100h cm e parti metalliche in acciaio inox lucido.

Satin black painted glass reception desk with 200x90x74h/100h cm and bright stainless steel metal parts.

Bureau en verre verni noir satiné de 200x90x74h/100h cm et parties métalliques en acier inox brillant.

Schreibtisch mit schwarz matt satiniertem Glas von 200x90x74h/100h cm. Metallteile Edelstahl (Inox) poliert.



- > Scrivania per reception in cristallo retroverniciato nero satinato da 200 x 90 x 74/100h cm e parti metalliche in acciaio inox lucido. Sedia OFX 09 85h cm in ecopelle bianca.
- Satin black painted glass reception desk with 200 x 90 x 74/100h cm and bright stainless steel metal parts. Chair OFX09 h85 cm in white eco-leather.
- Bureau en verre verni noir satiné de 200x90x74/100h cm et parties métalliques en acier inox brillant. Chaise OFX 09 h85 cm en simili cuir blanc.
- Schreibtisch mit schwarz matt satiniertem Glas von 200x90x74/100h cm. Metallteile Edelstahl (Inox) poliert. Stuhl OFX 09 h85 cm Spaltleder weiss.

- √ Suggestimenti per soluzioni personalizzate.
- Suggestions for customised options.
- Suggestions pour solutions personnalisées.
- Vorschläge für die persönliche Ausführungen.

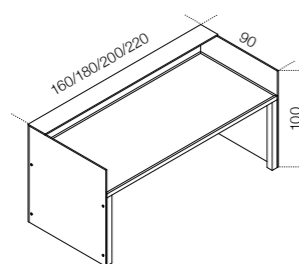
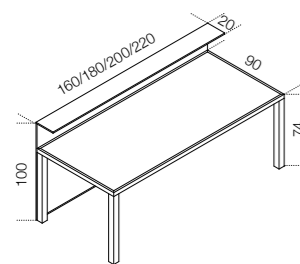
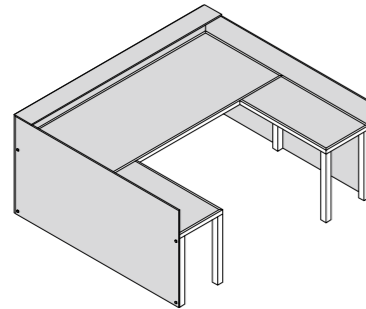
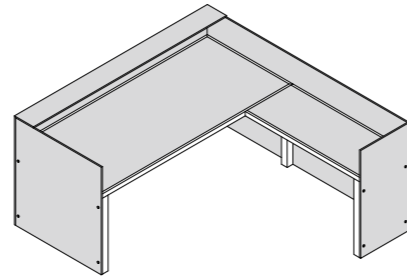
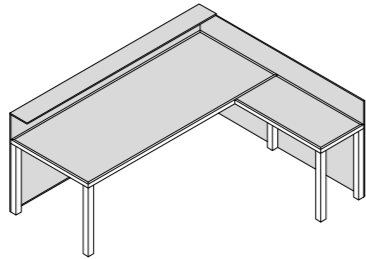

## Cm (L x P x H)

160 x 90 x 74/100  
 180 x 90 x 74/100  
 200 x 90 x 74/100  
 220 x 90 x 74/100

## Inches (W x D x H)

63" x 35½" x 29¼"/39½"  
 71" x 35½" x 29¼"/39½"  
 78¾" x 35½" x 29¼"/39½"  
 86¾" x 35½" x 29¼"/39½"



# Milano

## Milano

Scrivania direzionale con struttura e cassetti in frassino naturale, tinto tabacco o laccato nero poro aperto (mod. Layer). Piano in cristallo trasparente 15 mm. Disponibile anche piano in cristallo "grigio Italia" 12 mm. Sottomano in pelle scamosciata o cuoio, nei colori del campionario.

Executive desk with structure and drawers in natural ash, tobacco stained or black lacquered open pore (mod. Layer). 15 mm transparent glass top. Available also 12 mm smoked "grigio Italia" glass top. Suede or leather writing pad as per samples.

Bureau de direction avec structure et tiroirs en frêne naturel, teinté tabac ou laqué noir pore ouvert (mod. Layer). Plateau en verre transparent de 15 mms d'épaisseur. Disponible aussi plateau en verre "grigio Italia" fumé de 12 mms d'épaisseur. Sous-main en suédine ou cuir dans les coloris de nos échantillons.

Executivschreibtisch: Gestell und Schubladen Eschenholz, Tabakfarbe gebeizt oder schwarz off-pore lackiert (mod. Layer). Glasplatte 15 mm klar. Auch Glas Rauchglas "grigio Italia" 12 mm lieferbar. Schreibunterlage Wildleder oder Leder in den Farben nach Musterkarte.

## Milano 1

Scrivania direzionale in appoggio su Milano contenitore con ante e cassetti (fronte) e vani a giorno (retro).

Executive desk with one side resting on Milano unit with doors and drawers (front) and open (back).

Bureau de direction posé sur Milano meuble avec portes et tiroirs (avant) et ouvert (arrière).

Executivschreibtisch aufgesetzt auf Milano Element mit Türen und Schubladen (Front) und offen (Rückseite).

> Scrivania in appoggio su contenitore in frassino tinto tabacco e piano in cristallo trasparente extralight da 286x180 cm. Sedia OFX 09 h115 cm in pelle scamosciata Sand 06. Sottomano in pelle scamosciata Sand 06.

Desk with one side resting on tobacco stained ash unit and extralight transparent glass top 286x180 cm. Chair OFX 09 h115 cm in suede Sand 06. Suede Sand 06 leather writing pad.

Bureau avec un côté posé sur le meuble en frêne teinté tabac et plateau en verre transparent extralight 286x180 cm. Chaise OFX 09 h115 cm en suédine Sand 06. Sous-main en suédine Sand 06.

Schreibtisch aufgesetzt auf Möbel aus Eschenholz Tabakfarbe gebeizt und Glasplatte klar Extralight 286x180 cm. Stuhl OFX 09 h115 cm Wildleder Sand 06. Schreibunterlage aus Wildleder Sand 06.







Milano

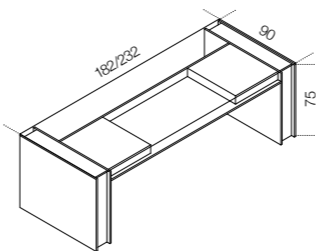

Milano 1

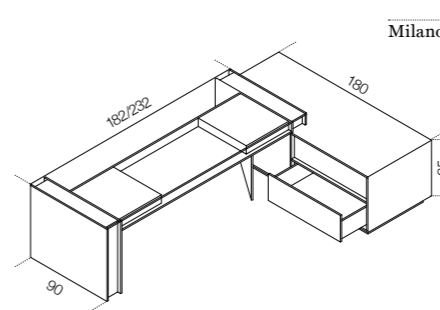

Milano

182 x 90 x 75  
232 x 90 x 75  
236 x 180 x 75  
286 x 180 x 75

Milano 1

Cm (L x P x H)  
182 x 90 x 75  
232 x 90 x 75  
236 x 180 x 75  
286 x 180 x 75

Inches (W x D x H)  
71 $\frac{3}{4}$ " x 35 $\frac{1}{2}$ " x 29 $\frac{3}{4}$ "  
91 $\frac{1}{2}$ " x 35 $\frac{1}{2}$ " x 29 $\frac{3}{4}$ "  
93" x 71" x 29 $\frac{3}{4}$ "  
112 $\frac{3}{4}$ " x 71" x 29 $\frac{3}{4}$ "

# **Cassettiere e Contenitori/ Drawer and Storage units/ Bloc tiroirs et Meubles/ Rollcontainer und Möbelcontainer**

98	Air Drawer
126	Air Lock
126	Air Stationery
110	Air Unit
118	Air Up
124	Air Up Shelf
100	Air Wheel
126	Cover Cable Plate 2
102	Movie Cassettiera
104	Movie Metal
128	Movie W11
130	Pandora
108	President Cassettiera
106	Techna
134	Tot

# Air Drawer

## Air Drawer



Cassettera in legno con lati rivestiti in cristallo retroverniciato nei colori del campionario nella versione brillante e satinata. Montata su ruote. Cassetti ad estrazione totale; fondo in cristallo trasparente. Il cassetto può essere dotato di un vassoio portacancelleria in alluminio. Disponibile con serratura solo sul primo cassetto.

Drawer unit in wood with sides covered by painted glass as per samples in the bright or satin version. On castors. Pull-out drawers; transparent glass bottom. The drawer can be supplied with one aluminium stationery tray. Available with lock on the first drawer only.

Bloc tiroir sur roulettes avec côtés recouvertes de verre verni dans les couleurs de nos échantillons dans la version brillante ou satinée. Tiroirs complètement extractibles; fond en verre transparent. Le tiroir peut avoir un plateau porte-plumes en aluminium. Disponible avec serrure uniquement sur le premier tiroir.

Rollcontainer aus Holz mit lackiertem Glasseiten umkleidet. Lackierung nach Musterkarte jeweils hochglanz oder matt satiniert. Schubladen mit Vollauszug und Boden aus Klarglas. Der Schublade wird auf Wunsch mit einer Utensilentablett aus Aluminium. Auf Wunsch mit Schloss auf der oberen Schublade.

> Cassettera rivestita in cristallo retroverniciato cemento satinato.

Drawer unit covered by satin cement painted glass.

Bloc tiroir recouvert de verre verni ciment satiné.

Rollcontainer mit zement matt satiniertem Glas umkleidet.

## Air Drawer 3

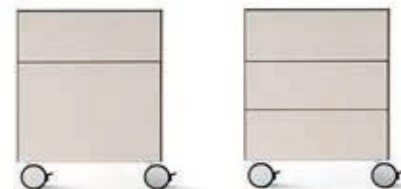

Cassettera in legno con lati rivestiti in cristallo retroverniciato nei colori del campionario nella versione brillante e satinata. Montata su ruote. A richiesta versione con zoccolo, da posizionare sotto la scrivania Air Desk. Cassetti ad estrazione totale con apertura push-pull; fondo in cristallo trasparente. Disponibile con serratura solo sul primo cassetto. A richiesta versione con cassetto per cartelle sospese. (Per Usa disponibile solo versione "letter size").

Drawer unit in wood with sides covered by painted glass as per samples in the bright or satin version. On castors. Version with base, to be placed underneath Air Desk, on request. Pull-out and push-pull drawers; transparent glass bottom. Available with lock on the first drawer only. Available with drawer for hanging files. (For Usa only "letter size" version available).

Bloc tiroir sur roulettes avec côtés recouvertes de verre verni dans les couleurs de nos échantillons dans la version brillante ou satinée. Sur demande version avec socle pour la positionner au dessous du bureau Air Desk. Tiroirs complètement extractibles avec ouverture push-pull; fond en verre transparent. Disponible avec serrure uniquement sur le premier tiroir. Sur demande version avec tiroir pour dossiers suspendus. (Pour Usa disponible seulement version "letter size").

Rollcontainer aus Holz mit lackiertem Glasseiten umkleidet. Lackierung nach Musterkarte jeweils hochglanz oder matt satiniert. Auf Wunsch Ausführung mit Sockel um unter dem Schreibtisch Air Desk zu stellen. Schubladen mit Vollauszug mit Push-Pull-Öffnung und Boden aus Klarglas. Lieferbar mit Schloss auf der oberen Schublade. Auf Wunsch auch Schublade mit Hängeregistratur (Für Usa nur "letter size" lieferbar).

Air Drawer

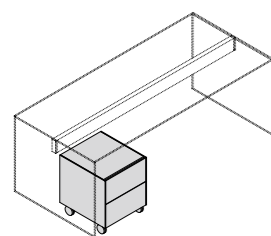

Air Drawer 3

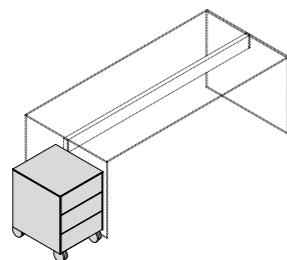
Air Drawer  
Air Drawer 3

Cm (L x P x H)  
47 x 51 x 56  
47 x 51 x 65

Inches (W x D x H)  
18 $\frac{3}{4}$ " x 20 $\frac{1}{4}$ " x 22 $\frac{1}{4}$ "  
18 $\frac{3}{4}$ " x 20 $\frac{1}{4}$ " x 25 $\frac{3}{4}$ "



# Air Wheel

Mobile contenitore montato su ruote ed interamente rivestito in cristallo retroverniciato nei colori del campionario, nella versione brillante o satinata. Disponibile anche in specchio extralight oppure in specchio "grigio Italia". Cassetti ad estrazione totale con fondo in cristallo trasparente. L'interno del mobile Air Wheel è in laminato effetto pelle. Su richiesta versione senza ruote, con zoccolo laminato effetto pelle (altezza totale 38 o 48 cm).

Wooden unit on castors with all sides covered by painted glass as per samples, in the bright or satin version. Available also in extralight mirror or smoked "grigio Italia" mirror. Total pull-out drawers with transparent bottom glass. The inside of Air Wheel is made of leather effect laminated wood. On request, version without castors, with leather effect laminated wooden plinth (total height 38 or 48 cm).

Meuble sur roulettes avec tous les côtés recouvertes de verre verni dans les coloris de nos échantillons dans la version brillante ou satinée. Disponible aussi en miroir extralight ou en miroir "grigio Italia" fumé. Tiroirs complètement extractibles et fond en verre transparent. La partie intérieure du meuble Air Wheel est revêtu en effet cuir. Disponible sans roulettes avec socle en bois revêtu en effet cuir (total hauteur 38 ou 48 cm).

Holzelement auf Rollen mit allen Seiten nach Musterkarte lackiertem Glas umkleidet. Lackierung jeweils hochglanz oder matt satiniert. Lieferbar auch in verspiegeltem Glas Extralight oder Spiegel-Rauchglas "grigio Italia". Schubladen mit Vollauszug und Boden aus Klarglas. Die Innenwände der Air Wheel sind aus Holz mit Leder-Effekt umkleidet. Auf Wunsch ohne Rollen mit Sockel aus Holz mit Leder-Effekt umkleidet (Gesamthöhe 38 oder 48 cm).

> Contenitore rivestito in cristallo retroverniciato oliva satinato da 137x51 x56h cm. Scrivania Air Desk in cristallo trasparente extralight da 180x90 x74h cm e parti metalliche in acciaio inox lucido. Sedia OFX 09 h115 cm in pelle scamosciata Sand 012.

Unit on castors 137x51 x56h cm in satin olive painted glass. Extralight transparent glass desk Air Desk 180x90x74h cm and bright stainless steel metal parts. Chair OFX 09 h115 cm in suede Sand 012.

Meuble sur roulettes 137 x51x56h cm recouvert de verre verni olive satiné. Bureau Air Desk en verre transparent extralight de 180x90x74h cm et parties métalliques en acier inox brillant. Chaise OFX 09 h115 cm en suédine Sand 012.

Rollcontainer 137x51 x56h cm mit olivenfarben matt satiniertem Glas umkleidet. Schreibtisch Air Desk aus Glas klar Extralight von 180x90 x74h cm und Metallteile Edelstahl (Inox) poliert. Stuhl OFX 09 h115 cm Wildleder Sand 012.

AWU01/U01S

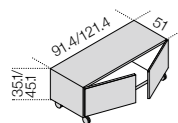

AWU02/U02S

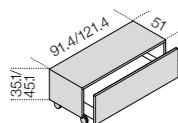

AWU02R/U02RS

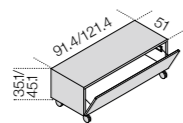

AW01

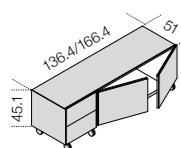

AW02/02X

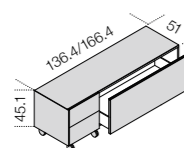

AW02R

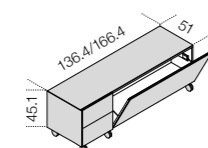

Cm (L x P x H)

91,4 x 51 x 46  
121,4 x 51 x 46  
91,4 x 51 x 56  
121,4 x 51 x 56  
136,4 x 51 x 56  
166,4 x 51 x 56

Inches (W x D x H)

36" x 20¼" x 18¼"  
48" x 20¼" x 18¼"  
36" x 20¼" x 22¼"  
48" x 20¼" x 22¼"  
53¾" x 20¼" x 22¼"  
65¾" x 20¼" x 22¼"



# Movie Cassettiera

Cassettiera in cristallo trasparente temperato 8 mm. Cassetti in legno laccato nero, bianco o grigio umbro a poro chiuso. Serratura solo sul primo cassetto. Parti metalliche in acciaio inox lucido. A richiesta acciaio inox satinato, ottone protetto o laccato bianco o nero goffrato. Ruote con freno.

Drawer unit in 8 mm transparent tempered glass. Black, white or dark grey lacquered closed pore wooden drawers. Lock on the first drawer only. Bright stainless steel metal parts. Satin stainless steel, protected brass or embossed white or black lacquered metal parts, on request. Castors with brake.

Bloc tiroir en verre transparent trempé de 8 mms d'épaisseur. Tiroirs en bois laqué noir, blanc ou gris foncé pore fermé. Serrure uniquement sur le premier tiroir. Parties métalliques en acier inox brillant. Sur demande acier inox satiné, laiton protégé ou laqué blanc ou noir gaufré. Roulettes avec frein.

Rollcontainer: vorgespanntes Glas klar 8 mm. 3 Schubladen Holz schwarz, weiss oder dunkelgrau decklackiert. Nur obere Schublade mit Schloss. Metallteile Edelstahl (Inox) poliert. Auf Wunsch Edelstahl (Inox) gebürstet, Messing zaponiert oder weiss oder schwarz strukturlackiert. Feststellbare Rollen.

> Cassettiera in cristallo trasparente e cassetti in legno laccato nero. Parti metalliche in acciaio inox lucido.

Transparent glass drawer unit with black lacquered wooden drawers. Bright stainless steel metal parts.

Bloc tiroir en verre transparent et tiroirs en bois laqué noir. Parties métalliques en acier inox brillant.

Rollcontainer Glas klar und Schubladen Holz Lack schwarz. Metallteile Edelstahl (Inox) poliert.

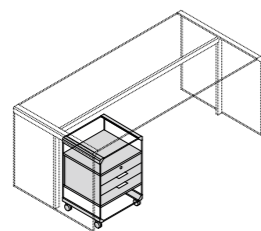

Cm (L x P x H)  
45 x 40 x 67

Inches (W x D x H)  
17¾" x 15¾" x 26½"



# Movie Metal

Cassettiera in cristallo trasparente temperato 8 mm. Cassetti in metallo laccato nero gofrato o bianco lucido. Parti metalliche in acciaio inox lucido. A richiesta acciaio inox satinato, ottone protetto o laccato bianco o nero gofrato. Apertura dei cassetti ad estrazione totale. Sistema di chiusura centralizzata. Disponibile nella versione con cassetto per cartelle sospese. (Per Usa disponibile solo versione "letter size"). Ruote con freno.

Drawer unit in 8 mm transparent tempered glass. Embossed black or bright white lacquered metal drawers. Bright stainless steel metal parts. Satin stainless steel, protected brass or embossed white or black lacquered metal parts, on request. Pull-out drawers. Centralized locking system. Available with drawer for hanging files. (For Usa only "letter size" version available). Castors with brake.

Bloc tiroir en verre transparent trempé de 8 mms d'épaisseur. Tiroirs en métal laqué noir gaufré ou blanc brillant. Parties métalliques en acier inox brillant. Sur demande acier inox satiné, laiton protégé ou laqué blanc ou noir gaufré. Tiroirs complètement extractibles. Fermeture des tiroirs centralisées. Disponible avec tiroir pour dossiers suspendus. (Pour Usa disponible seulement version "letter size"). Roulettes avec frein.

Rollcontainer: vorge-spanntes Glas klar 8 mm. 3 Schubladen Metall schwarz strukturlackiert oder Lack weiss glänzend. Metallteile Edelstahl (Inox) poliert. Auf Wunsch Edelstahl (Inox) gebürstet, Messing zaponiert oder weiss oder schwarz strukturlackiert. Schübe mit Vollauszug. Zentralverriegelung. Lieferbar auch Schublade mit Hängeregistratur. (Für Usa nur "letter size" lieferbar). Feststellbare Rollen.

> Cassettiera in cristallo trasparente e cassetti in metallo laccato bianco lucido. Parti metalliche in acciaio inox lucido.

Transparent glass drawer unit with bright white lacquered metal drawers. Bright stainless steel metal parts.

Bloc tiroir en verre transparent et tiroirs en métal laqué blanc brillant. Parties métalliques en acier inox brillant.

Rollcontainer Glas klar und Schubladen Metall Lack weiss glänzend. Metallteile Edelstahl (Inox) poliert.

Cm (L x P x H)  
45 x 50 x 74

Inches (W x D x H)  
17¾" x 19¾" x 29¼"

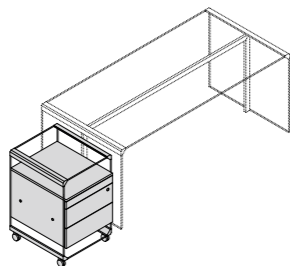

# Techna

## Techna



Cassetiera con cassetti in metallo laccato bianco o nero goffrato e lati rivestiti in cristallo retroverniciato bianco o nero nella versione brillante o satinata. Montata su ruote. Apertura dei cassetti ad estrazione totale. Sistema di chiusura centralizzata e meccanismo antiribaltamento. Cassetto portacancelleria. Disponibile nella versione con cassetto per cartelle sospese. (Per Usa disponibile solo versione "letter size").

Drawer unit with embossed white or black lacquered metal drawers and sides covered by white or black painted glass in the bright or satin version. On castors. Pull-out drawers. Centralized locking system. Stationery drawer. Available with drawer for hanging files. (For Usa only "letter size" version available).

Bloc tiroir sur roulettes avec tiroirs en métal laqué blanc ou noir gaufré et côtés revêtus de verre verni blanc ou noir dans la version brillante ou satiné. Tiroirs complètement extractibles et mécanisme de stabilisation. Fermeture des tiroirs centralisée. Tiroir porte-plumes. Disponible avec tiroir pour dossiers suspendus. (Pour Usa disponible seulement version "letter size").

Rollcontainer: Schubladen Metall weiss oder schwarz strukturlackiert mit Seitenteilen Lackiert. Lackierung jeweils hochglanz oder matt satiniert. Schubladen mit Vollauszug, Zentralverriegelung und Doppelauszugssperre. Utensilienschublade. Lieferbar auch Schublade mit Hängeregistratur. (Für Usa nur "letter size" lieferbar).

## Techna 13



Cassetiera in metallo laccato bianco o nero con frontali rivestiti in cristallo retroverniciato bianco o nero nella versione brillante o satinata. Montata su ruote. Sistema di chiusura centralizzata e meccanismo antiribaltamento. Cassetto interno portacancelleria.

Drawer unit in white or black lacquered metal with front panels covered by white or black painted glass in the bright or satin version. On castors. Centralized locking system and anti-tip mechanism. Inside stationery drawer.

Bloc tiroir sur roulettes en métal laqué blanc ou noir. Devant recouvert de verre verni blanc ou noir dans la version brillante ou satiné. Fermeture des tiroirs centralisée et mécanisme de stabilisation. Tiroir intérieur porte-plumes.

Rollcontainer aus Metall weiss oder schwarz lackiert mit Schubladenfront Glas weiss oder schwarz lackiert. Lackierung jeweils hochglanz oder matt satiniert. Zentralverriegelung und Doppelauszugssperre. Innenutensilienschublade.

> Cassetiera con cassetti in metallo laccato nero goffrato e lati rivestiti in cristallo retroverniciato nero brillante.

Drawer unit with embossed black lacquered metal drawers and sides covered by bright black painted glass.

Bloc tiroir avec tiroirs en métal laqué noir gaufré et côtés recouvertes de verre verni noir brillant.

Rollcontainer mit Schubladen aus Metall schwarz strukturlackiert und Seitenteilen Glas schwarz hochglänzend.

Techna

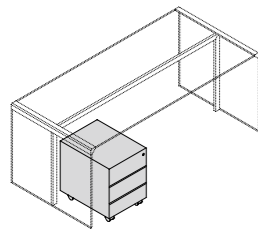

Techna 13

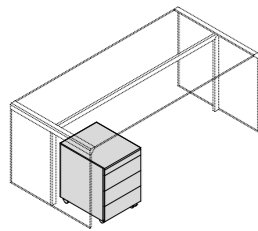

Techna

44 x 55 x 60

Techna 13

Cm (L x P x H)

44 x 55 x 60

42 x 56 x 54

Inches (W x D x H)

17½" x 21¾" x 23¾"

16¾" x 22¼" x 21½"



# President Cassettiera



Cassettiera in legno rivestito in specchio naturale o "grigio Italia". Montata su ruote. Cassetti in rovere sbiancato, tinto wengé o tinto tabacco. Disponibile anche laccato nero, bianco o grigio umbro a poro chiuso con interni in laminato melamminico di colore grigio. Serratura solo sul primo cassetto. Maniglie in ottone cromato. A richiesta due cassetti + cassetto per cartelle sospese. (Per Usa disponibile solo versione "letter size").

Drawer unit in wood with sides covered by mirror or smoked "grigio Italia" mirror. On castors. Whitened oak, wengé stained or tobacco stained drawers. Available also with black, white or dark grey closed pore lacquered frontal panels with inside in grey melamine laminated wood. Lock on the first drawer only. Chromed handles. Two drawers + drawer for hanging files, on request. (For Usa only "letter size" version available).

Bloc tiroir sur roulettes en bois recouvert de miroirs ou miroir "grigio Italia" fumé. Tiroirs en chêne blanchi, teinté wengé ou teinté tabac. Disponible aussi laqué noir, blanc ou gris foncé pore fermé avec intérieur en mélaminé de couleur gris. Serrure uniquement sur le premier tiroir. Poignées en laiton chromé. Sur demande deux tiroirs + un tiroir pour dossiers suspendus. (Pour Usa disponible seulement version "letter size").

Rollcontainer aus Holz mit Spiegel oder Spiegel-Rauchglas "grigio Italia" umkleidet. Schubladen Holz Eiche gebleicht, Wengé oder Tabakfarbe gebeizt. Lieferbar auch schwarz, weiss oder dunkelgrau decklackiert mit Innenseiten aus grauem Melamin. Obere Schublade mit Schloss. Griffe aus Messing verchromt. Auf Wunsch 2 Schubladen + 1 Schublade mit Hänge-registratur. (Für Usa nur "letter size" lieferbar).

> Cassettiera in legno rivestito in specchio "grigio Italia". Cassetti in rovere tinto tabacco. Maniglie in ottone cromato.

Drawer unit in wood with sides covered by smoked "grigio Italia" mirror. Tobacco stained oak drawers. Chromed handles.

Bloc tiroir sur roulettes en bois recouvert de miroir "grigio Italia" fumé. Tiroirs en chêne teinté tabac. Poignées en laiton chromé.

Rollcontainer aus Holz mit Spiegel-Rauchglas "grigio Italia" umkleidet. Schubladen Holz Eiche Tabakfarbe gebeizt. Griffe aus Messing verchromt.

Cm (L x P x H)  
46 x 46 x 65

Inches (W x D x H)  
18¼" x 18¼" x 25¾"

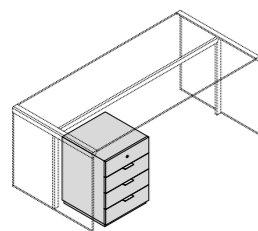



# Air

## Air Unit

Sistema modulare di contenitori in legno rivestito in cristallo retroverniciato nei colori del campionario nella versione brillante o satinata oppure in specchio extralight. Specchio "grigio Italia" solo per versione pensile e per i mobili U06, U06R e U06V. Disponibile con spalla portante in cristallo trasparente extralight temperato 12 mm oppure nella versione pensile. Per composizioni a centrostanza è previsto lo schienale in cristallo retroverniciato. Parti metalliche in alluminio anodizzato brill. L'interno del mobile Air Unit è in laminato effetto pelle.

Modular system of wooden elements covered by painted glass as per samples in the bright or satin version or in extralight mirror. Smoked "grigio Italia" mirror for suspended version and for the units U06, U06R and U06V only. Available as free-standing version with 12 mm tempered extralight transparent glass side or as suspended version. For compositions as a room divider is available a painted glass back. Bright anodised aluminium metal parts. The inside of Air Unit is made of leather effect laminated wood.

Système modulaire de meubles en bois recouvert de verre verni dans les coloris de nos échantillons dans la version brillante ou satinée ou en miroir extralight. Miroir "grigio Italia" seulement pour la version murale et pour les meubles U06, U06R et U06V. Disponible version sur pieds par spalles portantes en verre transparent extralight trempé de 12 mms d'épaisseur ou version murale. Pour le positionner comme séparateur de pièce est disponible le fond en verre verni. Parties métalliques en aluminium anodisé brillant. La partie intérieure du meuble Air Unit est revêtu en effet cuir.

Modulsystem aus Holzelementen mit nach Musterkarte lackiertem oder verspiegeltem Glas Extralight umkleidet. Lackierung jeweils hochglanz oder matt satiniert. Spiegel-Rauchglas "grigio Italia" nur für die Hänge-Ausführung und für Möbel U06, U06R und U06V. Lieferbar wie freistehende Komposition mit Seitenwange Glas klar Extralight vorgespannt 12 mm oder wie Hängekomposition. Sodass ein freistehender Einsatz möglich ist, wird mit lackiertem Glasrückwand geliefert. Metallteile eloxiertes Aluminium hochglänzend poliert. Die Innenwände der Air Unit-Möbel sind aus Holz mit Leder-Effekt umkleidet.

> Composizione pensile da 364x51x74h cm rivestita in cristallo retro verniciato oliva satinato. Sedie OFX 09 h85 cm in pelle scamosciata Sand 06.

Suspended composition 364x51x74h cm covered by satin olive painted glass. Chairs OFX 09 h85 cm in suede Sand 06.

Composition murale de 364x51x74h cm recouverte de verre verni olive satiné. Chaises OFX 09 h85 cm en suédine Sand 06.

Hänge-Komposition 364x51x74h cm mit olivfarben matt satiniertem Glas umkleidet. Stühle OFX 09 h85 cm Wildleder Sand 06.

>> Composizione da 244x51x91h cm rivestita in cristallo retroverniciato grigio beige brillante.

Composition 244x51x91h cm covered by bright taupe painted glass.

Composition de 244x51x91h cm recouverte de verre verni taupe brillant.

Komposition 244x51x91h cm mit beige-grau hochglänzendem lackiertem Glas umkleidet.

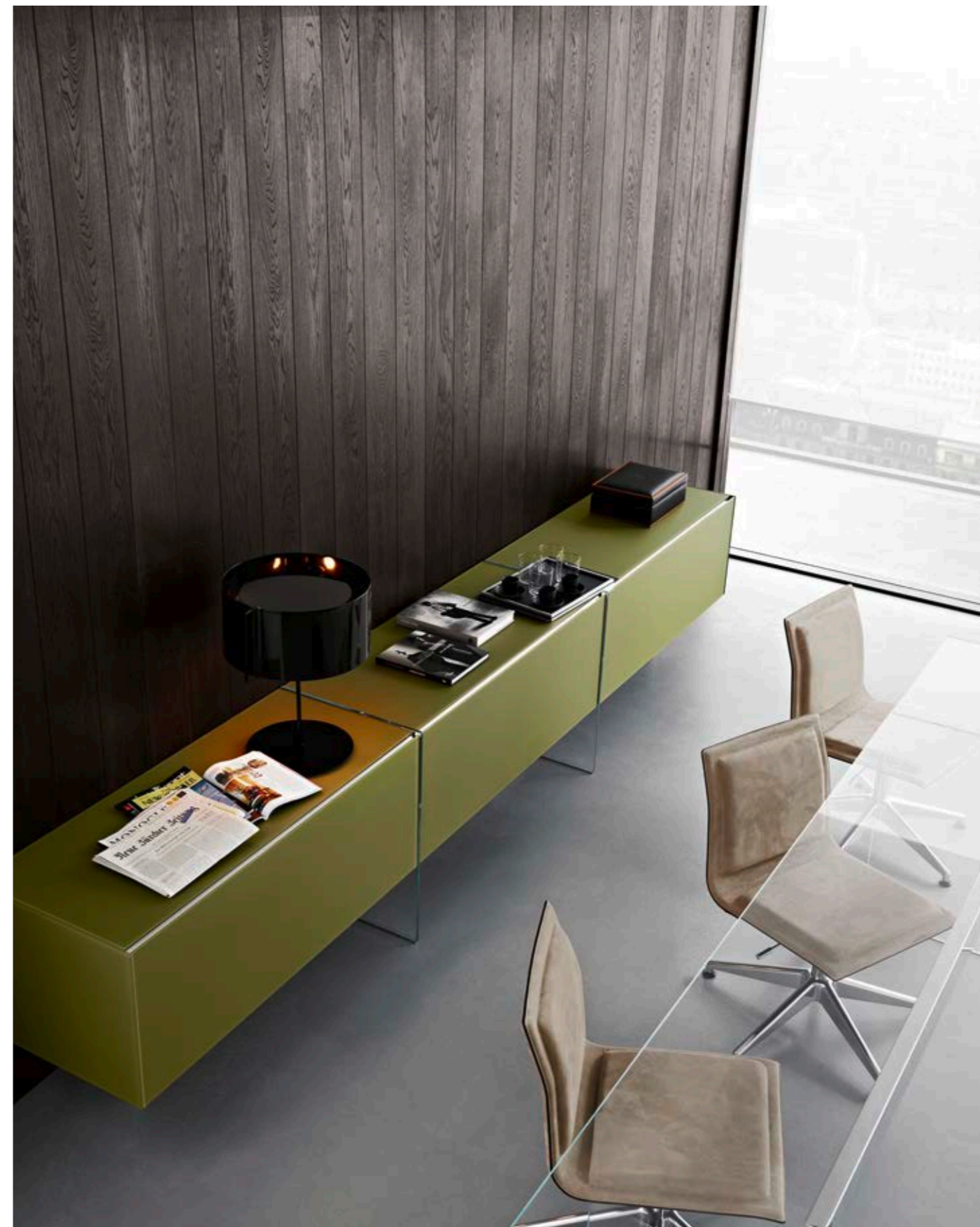



> Dettaglio dell'apertura a ribalta del modulo U06R. L'interno del mobile Air Unit è in laminato effetto pelle.

Detail of the flap door of the module U06R. The inside of Air Unit is made of leather effect laminated wood.

Détail de la porte abat-tante du meuble U06R. La partie intérieure du meuble Air Unit est revêtue en effet cuir.

Detail der Klapptür von U06R. Die Innenwände der Air Unit-Möbel sind aus Holz mit Leder-Effekt umkleidet.

Il sistema Air Unit è disponibile con spalla portante in cristallo trasparente extralight temperato 12 mm oppure nella versione pensile. Per composizioni a centrostanza è previsto lo schienale in cristallo retroverniciato. Parti metalliche in alluminio anodizzato brill.

Air Unit system is available as freestanding version with 12 mm tempered extralight transparent glass side or as suspended version. For compositions as room dividers, is available a painted glass back. Bright anodised aluminium metal parts.

Système Air Unit est disponible dans la version sur pieds par spalles portantes en verre transparent extralight trempé de 12 mms d'épaisseur ou dans la version murale. Pour le positionner comme séparateur de pièce est disponible un fond en verre verni. Parties métalliques en aluminium anodisé brillant.

Air Unit System ist wie freistehende Komposition mit Seitenwange Glas klar Extralight vorgespannt 12 mm oder wie Hängekomposition lieferbar. Sodass ein frestehender Einsatz möglich ist, wird mit lackiertem Glasrückwand geliefert. Metallteile eloxiertes Aluminium hochglänzend poliert.



A

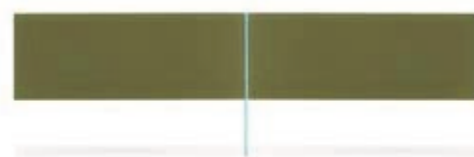

B



C



D

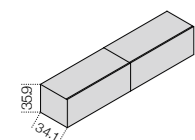

A Versione pensile U06. Disponibile solo per i moduli U06, U06R, U06V.

Suspended version U06. Available only for U06, U06R, U06V units.

Version murale U06. Disponible seulement pour les modules U06, U06R, U06V.

Hänge-Komposition U06. Lieferbar nur für die Module U06, U06R, U06V.

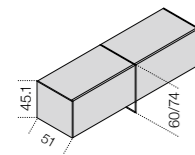

B Versione pensile + spalla intermedia. La spalla intermedia 60/74h cm è indispensabile per lo scarico del peso.

Suspended version + middle side. The 60/74h cm middle side is necessary to reduce the weight.

Version murale + côté intermediaire. Le côté intermediaire de 60/74h cm est indispensable pour reduire le poids.

Hänge-Komposition + Zwischenwange. Die Zwischenwange 60/74h cm ist notwendig für Gewichtsverteilung.

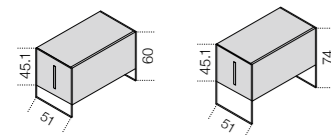

C Versione a spalla portante 60/74h cm.

Freestanding version 60/74h cm.

Version sur pieds par spalles portantes 60/74h cm.

Freistehende Komposition 60/74h cm.

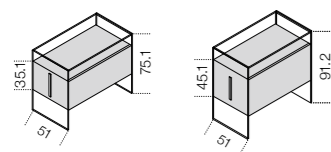

D Versione a spalla portante 75.1/91.2h cm con vano a giorno. Dimensione massima della composizione 365 cm.

Freestanding version 75.1/91.2h cm with open unit. Maximum length of the composition 365 cm.

Version sur pieds par spalles portantes 75.1/91.2h cm avec un espace ouvert. Longueur maximale de la composition 365 cm.

Freistehende Komposition 75.1/91.2h cm mit offenem Fach. Max. Länge der Komposition 365 cm.



Versione pensile + spalla intermedia 60/74h cm.    Suspended version + middle side 60/74h cm.    Version murale + côté intermédiaire 60/74h cm.    Hänge-Komposition + Zwischenwange 60/74h cm.

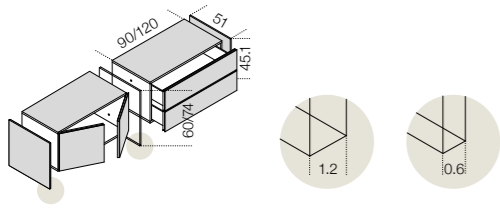

Versione a spalla portante 60/74h cm.    Freestanding version 60/74h cm.    Version sur pieds par spalles portantes 60/74h cm.    Freistehende Komposition 60/74h cm.

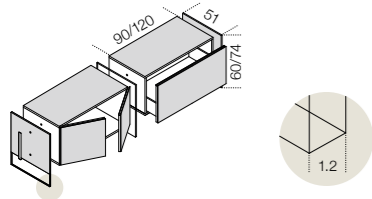

Versione a spalla portante 91.2h cm con vano a giorno.    Freestanding version 91.2h cm with open unit.    Version sur pieds par spalles portantes 91.2h cm avec un espace ouvert.    Freistehende Komposition 91.2h cm mit offenem Fach.

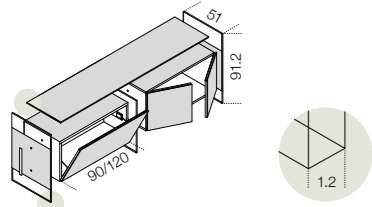

Moduli Air Unit h 45.1 cm.	Air Unit modules h 45.1 cm.	Meubles Air Unit h 45.1 cm.	Air Unit-Möbel h 45.1 cm.	Cm (L x P x H)	Inches (W x D x H)
				90 x 51 x 45.1	35½" x 20¼" x 18"
				120 x 51 x 45.1	47¼" x 20¼" x 18"

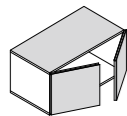

U01\*

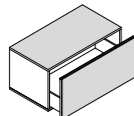

U02\*\*

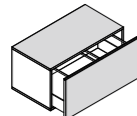

U02X

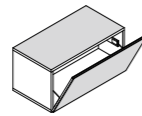

U02R

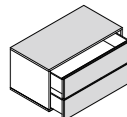

U03

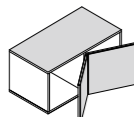

U04\*

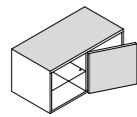

U05\*

Versione pensile U06.    Suspended version U06.    Version murale U06.    Hänge-Ausführung U06.

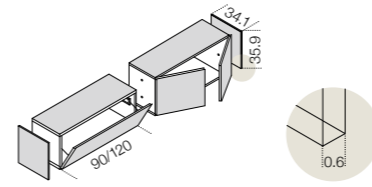

Moduli Air Unit h 35.9 cm.    Air Unit modules h 35.9 cm.    Meubles Air Unit h 35.9 cm.    Air Unit-Möbel h 35.9 cm.

Cm (L x P x H)	Inches (W x D x H)
90 x 34.1 x 35.9	35½" x 20¼" x 14"
120 x 34.1 x 35.9	47¼" x 20¼" x 14"
35.9 x 34.1 x 91.4	14¼" x 13½" x 36"
35.9 x 34.1 x 121.4	14¼" x 13½" x 48"

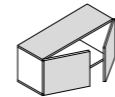

U06

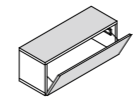

U06R

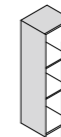

U06V

Versione a spalla portante 75.1h cm con vano a giorno.    Freestanding version 75.1h cm with open unit.    Version sur pieds par spalles portantes 75.1h cm avec un espace ouvert.    Freistehende Komposition 75.1h cm mit offenem Fach..

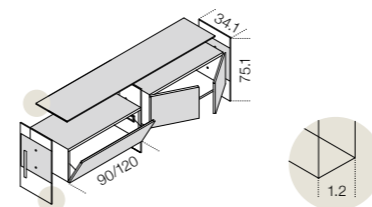

Moduli Air Unit h 35.1 cm.	Air Unit modules h 35.1 cm.	Meubles Air Unit h 35.1 cm.	Air Unit-Möbel h 35.1 cm.	Cm (L x P x H)	Inches (W x D x H)
				90 x 51 x 35.1	35½" x 20¼" x 14"
				120 x 51 x 35.1	47¼" x 20¼" x 14"

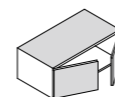

U01S\*

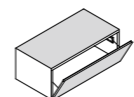

U02RS

\*Può essere dotato di ripiano interno in cristallo trasparente extralight.

\*It can be supplied with one inside extralight transparent glass shelf.

\*Il peut être livré avec une tablette intérieure en verre transparent extralight.

\*Es wird auf Wunsch mit einem Innenboden aus Extralight Glas geliefert.

\*\*Può essere dotato di un cassetto interno.

\*\*It can be supplied with one inside drawer.

\*\*Il peut être livré avec un tiroir intérieur.

\*\*Es wird auf Wunsch mit einer Innenschublade geliefert.

**Air Up**

Sistema di mobili contenitori sovrapposti in legno rivestito in cristallo retroverniciato nei colori del campionario, nella versione brillante o satinata oppure in specchio extralight o specchio "grigio Italia". Base e distanziatori in legno laminato effetto pelle. Parti metalliche in alluminio anodizzato brill. Per composizioni a centrostanza è previsto lo schienale in cristallo retroverniciato. L'interno del mobile Air Up è in laminato effetto pelle.

Modular system of superimposed wooden elements covered by painted glass as per samples, in the bright or satin version or in extralight mirror or smoked "grigio Italia" mirror. Base and spacers in leather effect laminated wood. Bright anodised aluminium metal parts. For compositions as room divider, is available a painted glass back. The inside of Air Up is made of leather effect laminated wood.

Système modulaire de meubles superposés en bois recouvert de verre verni dans les coloris de nos échantillons dans la version brillante ou satinée ou en miroir extralight ou miroir "grigio Italia". Socle et pièces entretoisées en bois revêtu en effet cuir. Parties métalliques en aluminium anodisé brillant. Pour le positionner comme séparateur de pièce est disponible le fond en verre verni. La partie intérieure du meuble Air Up est revêtu en effet cuir.

Modulsystem aus aneinandergesetzten Holzelementen mit nach Musterkarte lackiertem oder verspiegeltem Extralight Glas oder Spiegel-Rauchglas "grigio Italia" umkleidet. Lackierung jeweils hochglanz oder matt satiniert. Holzsockel und Abstandteile mit Leder-Effekt umkleidet. Metallteile eloxiertes Aluminium hochglänzend poliert. Sodass ein freistehender Einsatz möglich ist, wird mit lackiertem Glasrückwand geliefert. Die Innenwände der Air Up-Möbel sind aus Holz mit Leder-Effekt umkleidet.

> Composizione da 121,5x51 x143h cm rivestita in cristallo retroverniciato grigio beige brillante. Tavolino Raj 2.

Composition 121,5x51 x143h cm covered by bright taupe painted glass. Raj 2.

Composition de 121,5x51 x143h cm recouverte de verre verni taupe brillant. Raj 2 table basse.

Komposition 121,5x51 x143h cm mit beige-grau hochglänzendem lackiertem Glas umkleidet. Raj 2 Couchtisch.

>> Vassoio portacancellaria in alluminio applicabile al cassetto del mobile U02/U03.

Aluminium stationery tray available for the drawer of the unit U02/U03.

Plateau porte-plumes en aluminium disponible pour le tiroir du meuble U02/U03.

Utensilientablett aus Aluminium kann auf der Schublade von dem Modul U02/U03 angebracht werden.

>> Cassetto ad estrazione totale con fondo in cristallo trasparente.

Total pull-out drawer with transparent glass bottom.

Tiroir complètement extractible et fond en verre transparent.

Schublade mit Vollauszug und Boden aus Klarglas.





## Drawer and Storage units

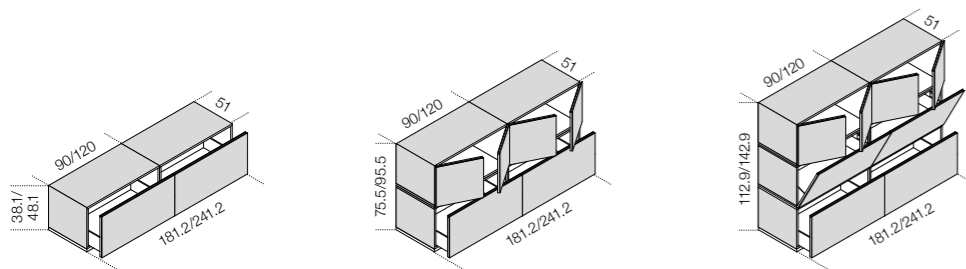

Moduli Air Up h 48.1 cm.	Air Up modules h 48.1 cm.	Meubles Air Up h 48.1 cm.	Air Up-Möbel h 48.1 cm.	Cm (L x P x H)	Inches (W x D x H)
				90 x 51 x 48.1	35½" x 20¼" x 19"
				120 x 51 x 48.1	47¼" x 20¼" x 19"

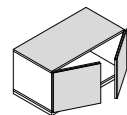

U01 UP\*

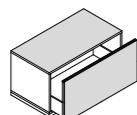

U02 UP\*\*

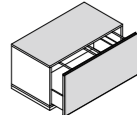

U02X UP

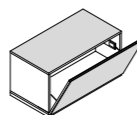

U02R UP

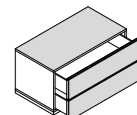

U03 UP

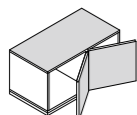

U04 UP\*

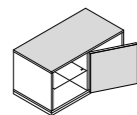

U05 UP\*

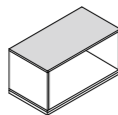

U07 UP\*

Moduli Air Up Sh 38.1 cm.	Air Up S modules h 38.1 cm.	Meubles Air Up S h 38.1 cm.	Air Up S-Möbel h 38.1 cm.	Cm (L x P x H)	Inches (W x D x H)
				90 x 51 x 38.1	35½" x 20¼" x 15¼"
				120 x 51 x 38.1	47¼" x 20¼" x 15¼"

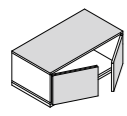

U01S UP\*

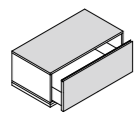

U02S UP

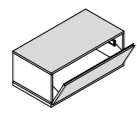

U02RS UP

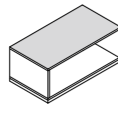

U07S UP\*

\*Può essere dotato di ripiano interno in cristallo trasparente extralight.

\*It can be supplied with one inside extralight transparent glass shelf.

\*Il peut être livré avec une tablette intérieure en verre transparent extralight.

\*Es wird auf Wunsch mit einem Innenboden aus Extralight Glas geliefert.

\*\*Può essere dotato di un cassetto interno.

\*\*It can be supplied with one inside drawer.

\*\*Il peut être livré avec un tiroir intérieur.

\*\*Es wird auf Wunsch mit einer Innenschublade geliefert.



## Air Up Shelf

Sistema di mobili contenitori sovrapposti in legno rivestito in cristallo retroverniciato nei colori del campionario, nella versione brillante o satinata oppure in specchio extralight. Base e distanziatori in legno laminato effetto pelle. Parti metalliche in alluminio anodizzato brill. Per composizioni a centrostanza è previsto lo schienale in cristallo retroverniciato. L'interno del mobile Air Up Shelf è in laminato effetto pelle. Spalla in cristallo trasparente extralight temperato 12 mm retroverniciata o specchiata in corrispondenza del fianco del mobile. Top in cristallo trasparente extralight temperato 12 mm.

Modular system of superimposed wooden elements covered by painted glass as per samples, in the bright or satin version or in extralight mirror. Base and spacers in leather effect laminated wood. Bright anodised aluminium metal parts. For room dividers, a painted glass back is available. The inside of Air Up Shelf is made of leather effect laminated wood. 12 mm extralight transparent glass side, painted or mirrored in the part corresponding to the unit's side. 12 mm extralight transparent tempered glass top.

Système modulaire de meubles superposés en bois recouvert de verre verni dans les coloris de nos échantillons dans la version brillante ou satinée ou en miroir extralight. Socle et pièces entretoisées en bois revêtu en effet cuir. Parties métalliques en aluminium anodisé brillant. Pour le positionner comme séparateur de pièce est disponible le fond en verre verni. La partie intérieure du meuble Air Up Shelf est revêtu en effet cuir. Côté en verre transparent extralight trempé de 12 mms d'épaisseur, vernie ou miroitée dans la partie correspondante à la côté du meuble. Top en verre transparent extralight trempé de 12 mms d'épaisseur.

Modulsystem aus aneinandergesetzten Holzelementen mit nach Musterkarte lackiertem oder verspiegeltem Extralight Glas. Lackierung jeweils hochglanz oder matt satiniert. Holzsockel und Abstandteile mit Leder-Effekt umkleidet. Metallteile eloxiertes Aluminium hochglänzend poliert. Sodass ein freistehender Einsatz möglich ist, wird mit lackiertem Glasrückwand geliefert. Die Innenwände der Air Up Shelf-Möbel sind aus Holz mit Leder-Effekt umkleidet. Seitenwange aus vorgespanntem Glas klar Extralight 12 mm lackiert oder verspiegelt entsprechend der Möbelseite. Abdeckboden aus vorgespanntem Glas klar Extralight 12 mm.

> Composizione da 365x51 x133,4h cm rivestita in cristallo retroverniciato cemento brillante.

Composition 365x51 x133,4h cm covered by bright cement painted glass.

Composition de 365x51 x133,4h cm recouverte de verre verni ciment brillant.

Komposition 365x51 x133,4h cm mit zement hochglänzendem lackiertem Glas umkleidet.

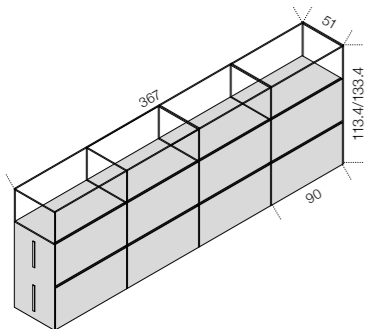
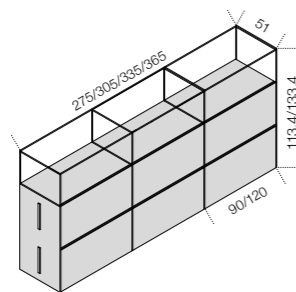
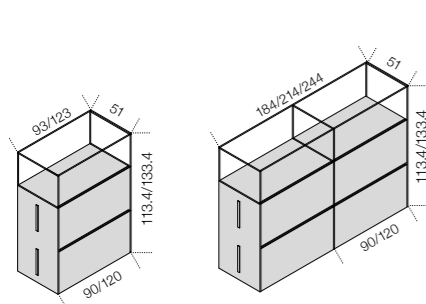

## Cm (L x P x H)

93 x 51 x 113.4  
123 x 51 x 113.4  
184 x 51 x 113.4  
214 x 51 x 113.4  
244 x 51 x 113.4  
275 x 51 x 113.4  
305 x 51 x 113.4  
335 x 51 x 113.4  
365 x 51 x 113.4  
367 x 51 x 113.4  
93 x 51 x 133.4  
123 x 51 x 133.4  
184 x 51 x 133.4  
214 x 51 x 133.4  
244 x 51 x 133.4  
275 x 51 x 133.4  
305 x 51 x 133.4  
335 x 51 x 133.4  
365 x 51 x 133.4  
367 x 51 x 133.4

## Inches (W x D x H)

36<sup>3</sup>/<sub>4</sub>" x 20<sup>1</sup>/<sub>4</sub>" x 44<sup>3</sup>/<sub>4</sub>"  
48<sup>1</sup>/<sub>2</sub>" x 20<sup>1</sup>/<sub>4</sub>" x 44<sup>3</sup>/<sub>4</sub>"  
72<sup>1</sup>/<sub>2</sub>" x 20<sup>1</sup>/<sub>4</sub>" x 44<sup>3</sup>/<sub>4</sub>"  
84<sup>1</sup>/<sub>2</sub>" x 20<sup>1</sup>/<sub>4</sub>" x 44<sup>3</sup>/<sub>4</sub>"  
96<sup>1</sup>/<sub>4</sub>" x 20<sup>1</sup>/<sub>4</sub>" x 44<sup>3</sup>/<sub>4</sub>"  
108<sup>1</sup>/<sub>2</sub>" x 20<sup>1</sup>/<sub>4</sub>" x 44<sup>3</sup>/<sub>4</sub>"  
120<sup>1</sup>/<sub>4</sub>" x 20<sup>1</sup>/<sub>4</sub>" x 44<sup>3</sup>/<sub>4</sub>"  
132" x 20<sup>1</sup>/<sub>4</sub>" x 44<sup>3</sup>/<sub>4</sub>"  
143<sup>3</sup>/<sub>4</sub>" x 20<sup>1</sup>/<sub>4</sub>" x 44<sup>3</sup>/<sub>4</sub>"  
144<sup>1</sup>/<sub>2</sub>" x 20<sup>1</sup>/<sub>4</sub>" x 44<sup>3</sup>/<sub>4</sub>"  
36<sup>3</sup>/<sub>4</sub>" x 52<sup>1</sup>/<sub>2</sub>" x 44<sup>3</sup>/<sub>4</sub>"  
48<sup>1</sup>/<sub>2</sub>" x 52<sup>1</sup>/<sub>2</sub>" x 44<sup>3</sup>/<sub>4</sub>"  
72<sup>1</sup>/<sub>2</sub>" x 52<sup>1</sup>/<sub>2</sub>" x 44<sup>3</sup>/<sub>4</sub>"  
84<sup>1</sup>/<sub>2</sub>" x 52<sup>1</sup>/<sub>2</sub>" x 44<sup>3</sup>/<sub>4</sub>"  
96<sup>1</sup>/<sub>4</sub>" x 52<sup>1</sup>/<sub>2</sub>" x 44<sup>3</sup>/<sub>4</sub>"  
108<sup>1</sup>/<sub>2</sub>" x 52<sup>1</sup>/<sub>2</sub>" x 44<sup>3</sup>/<sub>4</sub>"  
120<sup>1</sup>/<sub>4</sub>" x 52<sup>1</sup>/<sub>2</sub>" x 44<sup>3</sup>/<sub>4</sub>"  
132" x 52<sup>1</sup>/<sub>2</sub>" x 44<sup>3</sup>/<sub>4</sub>"  
143<sup>3</sup>/<sub>4</sub>" x 52<sup>1</sup>/<sub>2</sub>" x 44<sup>3</sup>/<sub>4</sub>"  
144<sup>1</sup>/<sub>2</sub>" x 52<sup>1</sup>/<sub>2</sub>" x 44<sup>3</sup>/<sub>4</sub>"





### Air Lock



La serratura puo' essere applicata a richiesta sui moduli contenitori e solo sul primo cassetto del modulo U03 e della cassettoiera Air Drawer.

The lock is available on the units and on the first drawer only of the module U03 and of Air Drawer (drawer unit), on request.

La serrure est disponible, sur demande, sur les meubles et uniquement sur le premier tiroir du meuble U03 et du bloc tiroir Air Drawer.

Schloss möglich auf Wunsch auf der Module und nur auf der oberen Schublade von Modul U03 und von Rollcontainer Air Drawer.

### Air stationery



Vassoio portacancelleria in alluminio applicabile al cassetto dei mobili U02/U03 e Air Drawer.

Aluminium stationery tray available for the drawer of the units U02/U03 and Air Drawer.

Plateau porte-plumes en aluminium disponible pour le tiroir des meubles U02/U03 et Air Drawer.

Utensilientablett aus Aluminium kann auf der Schublade von dem Modul U02/U03 und Air Drawer angebracht werden.

### Cover cable plate 2

I moduli contenitori possono essere dotati di sistema passacavi in alluminio brill.

Units available with bright aluminium cable management system.

Meubles disponibles avec système pour le passage des câbles en aluminium brillant.

Module mit Kabeldurchlass aus Aluminium hochglänzend poliert lieferbar.



# Movie W 11

Mobile in cristallo trasparente temperato 8 mm. Divisori e contenitori in frassino naturale o tinto tabacco con frontali in cristallo retroverniciato nei colori del campionario nella versione brillante o satinata. Cassetti ad estrazione totale. Parti metalliche in acciaio inox lucido o satinato.

Element in 8 mm tempered transparent glass. Natural ash or tobacco stained dividers and units with painted glass fronts as per samples in the bright or satin version, on request. Total pull-out drawers. Bright or satin stainless steel metal parts.

Élément en verre transparent trempé de 8 mm d'épaisseur. Séparateurs et meubles en frêne naturel ou teinté tabac avec frontaux en verre verni dans les coloris de nos échantillons dans la version brillante ou satinée. Tiroirs complètement extractibles. Parties métalliques en acier inox brillant ou satiné.

Element: vorgespanntes Glas klar 8 mm. Trennteile und Elemente aus Eschenholz oder Tabakfarbe gebeizt mit Fronten lackiert nach Musterkarte. Lackierung jeweils hochglanz oder matt satiniert. Schubladen mit Vollauszug. Metallteile Edelstahl (Inox) poliert oder gebürstet.

> Mobile in cristallo trasparente extralight da 112 x40x151h cm (D1\_112). Divisori e contenitori in frassino tinto tabacco con frontali in cristallo retroverniciato cadet blu satinato e cemento satinato. Parti metalliche in acciaio inox satinato.

Extralight transparent glass element 112x40 x151h cm (D1\_112). Tobacco stained ash dividers and units with satin cadet blue and satin cement painted glass fronts. Satin stainless steel metal parts.

Élément en verre transparent extralight de 112 x40x151h cm (D1\_112). Séparateurs et meubles en frêne teinté tabac avec frontaux en verre verni cadet bleu satiné et ciment satiné. Parties métalliques en acier inox satiné.

Element Glas klar Extralight 112x40x151h cm (D1\_112). Trennteile und Elemente aus Eschenholz Tabakfarbe gebeizt mit kadettenblau und zement matt satiniertem Glasfronten. Metallteile Edelstahl (Inox) gebürstet.

A1\_94

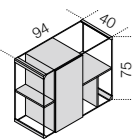

B2\_142

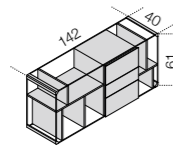

C1\_183

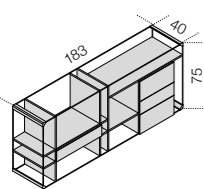

D1\_112

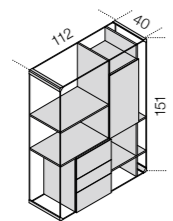

	Cm (L x P x H)	Inches (W x D x H)
A1_94	94 x 40 x 75	37 $\frac{1}{4}$ " x 15 $\frac{3}{4}$ " x 29 $\frac{3}{4}$ "
B2_142	142 x 40 x 61	56" x 15 $\frac{3}{4}$ " x 24 $\frac{1}{2}$ "
C1_183	183 x 40 x 75	72 $\frac{1}{2}$ " x 15 $\frac{3}{4}$ " x 29 $\frac{3}{4}$ "
D1_112	112 x 40 x 151	44 $\frac{1}{4}$ " x 15 $\frac{3}{4}$ " x 59 $\frac{1}{2}$ "



# Pandora

Madia in cristallo temperato 8 mm, rivestito in foglia oro applicata con lavorazione manuale ed esclusiva. Grazie a questo trattamento, il contenitore assume una colorazione disomogenea e unica all'esterno e mantiene la finitura dorata all'interno. Struttura in metallo verniciato bronzo patinato. Collezione in edizione numerata.

Sideboard in 8 mm tempered glass covered by gold leaf applied by hand with an exclusive treatment. After this process the unit has an irregular and unique finish outside and a gold finish inside. Patinated bronze lacquered metal structure. Collection in numbered edition.

Crédence en verre trempé de 8 mms d'épaisseur recouvert de feuille d'or posée à la main avec méthode exclusif. Après ce travail le meuble aura un couleur pas uniforme et un caractère unique à l'extérieur et une finition dorée à l'intérieur. Structure en métal laqué bronze patiné. Collection en édition numérotée.

Sideboard: Glas vorgespannt 8 mm. Die Ausführung ist aus handgeklebtem Blattgold, in exklusiver Art und Weise verarbeitet. Dieses Verfahren ergibt aussen eine ungleiche und einzigartige Färbung während das Innere goldfarben ist. Gestell aus Metall bronzefarben patiniert lackiert. Kollektion in nummerierter Auflage.

> Madia in cristallo temperato 8 mm, rivestito in foglia oro. Struttura in metallo verniciato bronzo patinato. Collezione in edizione numerata.

Sideboard in 8 mm tempered glass covered by gold leaf. Patinated bronze lacquered metal structure. Collection in numbered edition.

Crédence en verre trempé de 8 mms d'épaisseur recouvert de feuille d'or. Structure en métal laqué bronze patiné. Collection en édition numérotée.

Sideboard: Glas vorgespannt 8 mm. Die Ausführung ist aus handgeklebtem Blattgold. Gestell aus Metall bronzefarben patiniert lackiert. Kollektion in nummerierter Auflage.

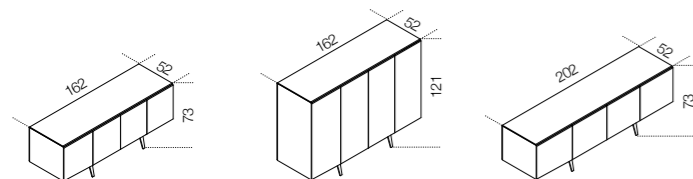

Cm (L x P x H)

162 x 52 x 71  
162 x 52 x 121  
202 x 52 x 71

Inches (W x D x H)

64" x 20½" x 28"  
64" x 20½" x 47¾"  
79¾" x 20½" x 28"



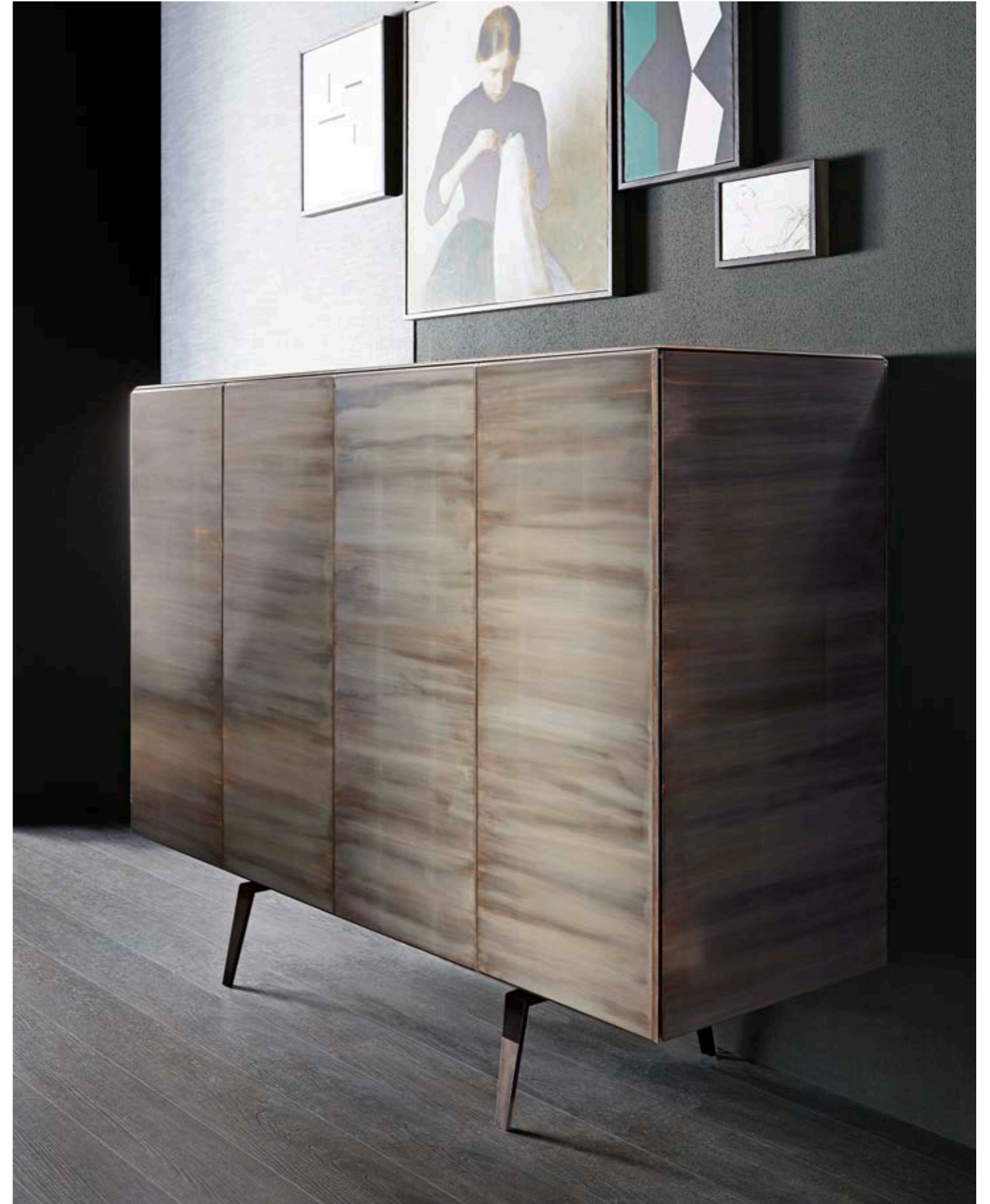

# Tot

Mobile contenitore girevole in legno laccato effetto tessuto nei colori castagna, sabbia, canapa. Due lati rivestiti in cristallo retroverniciato nei colori del campionario nella versione brillante o satinata e un lato specchiato. Un'asta appendiabiti in dotazione. Su richiesta versione con ripiani interni in cristallo trasparente extralight.

Rotating storage unit in lacquered wood with "fabric" touch effect in the colours chestnut, sand, canapa. Two sides covered by painted glass as per samples in the bright or satin version and one side covered by mirror. Supplied with one clothes rail. Version with inside extralight transparent glass shelves, on request.

Meuble tournant en bois laqué avec effet tissu dans les coloris châtaigne, sable, chanvre. Deux côtés recouvertes de verre verni dans les coloris de nos échantillons dans la version brillante ou satinée et un côté recouvert de miroir. De série avec une tige portemanteau. Sur demande version avec tablettes intérieurs en verre transparent extralight.

Drehbarmöbel: Holz lackiert mit Stoff-Effekt in kastanienbraun, sandfarben, hanffarben. 2 Seiten Glas lackiert nach Musterkarte. Lackierung jeweils hochglanz oder matt satiniert. 1 Seite Glas verspiegelt. Eine Kleiderstange inklusive. Auf Wunsch Ausführung mit Innenböden Glas klar Extralight.

> Mobile contenitore in legno laccato effetto tessuto color canapa e cristallo retroverniciato cemento satinato.

Storage unit in canapa with "fabric" touch effect lacquered wood and satin cement painted glass.

Meuble en bois laqué chanvre en effet tissu et verre verni ciment satiné.

Möbel aus Holz hanffarben mit Stoff-Effekt lackiert und Glas zement matt satiniert.

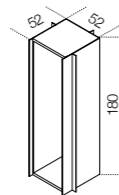
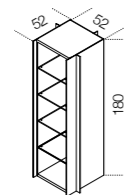

Cm (L x P x H)  
52 x 52 x 180

Inches (W x D x H)  
20½" x 20½" x 71"



**Librerie e Boiserie/  
Shelving systems  
and Boiserie/  
Bibliothèques et Boiserie/  
Regale und Boiserie**

148 Dipsy  
144 Drizzle  
138 EllePlus10  
150 Tortona

# Elle Plus 10

Boiserie in legno rivestito in cristallo specchiato extralight o specchio "grigio Italia" oppure retroverniciato nei colori del campionario nella versione brillante o satinata. Disponibile anche in frassino naturale, tinto tabacco o tinto wengé. Mensole in cristallo extralight 8 mm. Profili in alluminio brill.

Wooden boiserie covered by extralight mirror or smoked "grigio Italia" mirror or painted glass as per samples in the bright or satin version. Available also in natural ash, tobacco stained or wengé stained. 8 mm extralight glass shelves. Bright aluminium frame.

Boiserie en bois recouvert de verre miroité ou miroir "grigio Italia" fumé ou verni dans les coloris de nos échantillons dans la version brillante ou satinée. Disponible aussi en frêne naturel, teinté tabac ou teinté wengé. Tablettes en verre extralight de 8 mms d'épaisseur. Cadre en aluminium brillant.

Holzboiserie mit Glas verspiegelt oder Spiegel-Rauchglas "grigio Italia" oder lackiert nach Musterkarte umkleidet. Lackierung jeweils hochglanz oder matt satiniert. Lieferbar auch Eschenholz natur, Tabakfarbe gebeizt oder Wengé gebeizt. Böden Glas Extralight 8 mm. Rahmen aus Aluminium hochglänzend poliert.

> Boiserie da 90x28,5x174h cm rivestita in cristallo retroverniciato grigio umbro brillante. Sedia OFX 09 h85 cm in pelle scamosciata Sand 06.

Boiserie 90x28,5x174h cm covered by bright dark grey painted glass. Chair OFX 09 h85 cm in suede Sand 06.

Boiserie de 90x28,5x174h cm recouverte de verre verni gris foncé brillant. Chaise OFX 09 h85 cm en suédine Sand 06.

Boiserie 90x28,5x174h cm mit dunkel grau hochglänzendem lackiertem Glas umkleidet. Stuhl OFX 09 h85 cm Wildleder Sand 06.

>> Boiserie da 481x28,5x140h cm rivestita in cristallo retroverniciato champagne satinato. Composizione Air Unit pensile da 482x35x36h cm (U06) rivestita in cristallo retroverniciato champagne satinato.

Boiserie 481x28,5x140h cm covered by satin champagne painted glass. Air Unit suspended composition 482x35x36h cm (U06) covered by satin champagne painted glass.









Boiserie de 481x28,5x140h cm recouverte de verre verni champagne satiné. Composition murale Air Unit de 482x35x36h cm (U06) recouvert de verre verni champagne satiné.

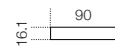
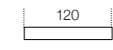
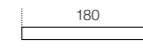
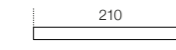
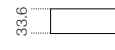
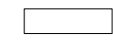
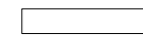
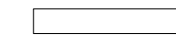

Boiserie 481x28,5x140h cm mit champagne matt satiniertem Glas umkleidet. Hänge-Komposition Air Unit 482x35x36h cm (U06) mit champagne matt satiniertem Glas umkleidet.



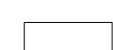

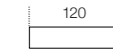
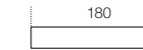

Schienale	Back	Fond	Rückwand	Cm (L x P x H)	Inches (W x D x H)
				90 x 2 x 16	35½" x 1" x 6½"
				120 x 2 x 16	47¼" x 1" x 6½"
				180 x 2 x 16	71" x 1" x 6½"
				210 x 2 x 16	82¾" x 1" x 6½"
				240 x 2 x 16	94½" x 1" x 6½"
				90 x 2 x 33,7	35½" x 1" x 13¼"
				120 x 2 x 33,7	47¼" x 1" x 13¼"
				180 x 2 x 33,7	71" x 1" x 13¼"
				210 x 2 x 33,7	82¾" x 1" x 13¼"
				240 x 2 x 33,7	94½" x 1" x 13¼"
				90 x 2 x 68,7	35½" x 1" x 27¼"
				120 x 2 x 68,7	47¼" x 1" x 27¼"
				180 x 2 x 68,7	71" x 1" x 27¼"
				210 x 2 x 68,7	82¾" x 1" x 27¼"
				240 x 2 x 68,7	94½" x 1" x 27¼"
				90 x 2 x 103,7	35½" x 1" x 41"
				120 x 2 x 103,7	47¼" x 1" x 41"

Mensole in cristallo (altezza totale della mensola incluso il profilo reggi-mensola: 13 mm).	Glass shelves (total height including metal support for shelf: 13 mm).	Tablettes en verre (hauteur totale avec support en métal inclus: 13 mm).	Glasböden (Gesamthöhe inklusiv Metallbodenträger: 13 mm).	Cm (L x P)	Inches (W x D)
				90 x 25	35½" x 10"
				120 x 25	47¼" x 10"
				180 x 25	71" x 10"
				210 x 25	82¾" x 10"
				240 x 25	94½" x 10"

Esempi di composizione	Composition examples	Exemples de compositions	Zusammensetzungenbeispiele
------------------------	----------------------	--------------------------	----------------------------

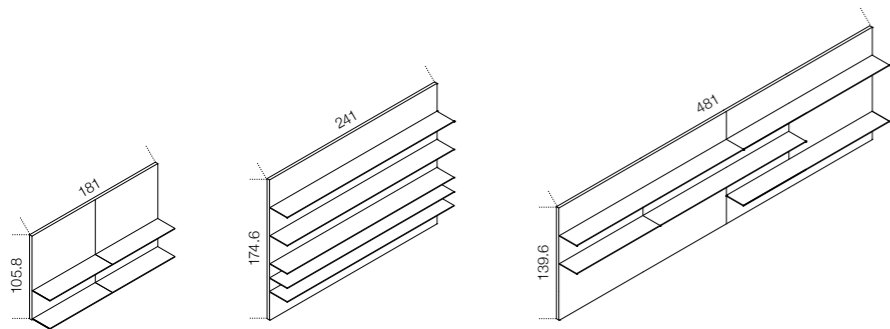

- > Dettaglio boiserie rivestita in tinto tabacco e cristallo specchiato "grigio Italia".
- Boiserie detail covered by tobacco stained and smoked "grigio Italia" mirrored glass.
- Détail de la boiserie recouverte en teinté tabac et verre miroité "grigio Italia" fumé.
- Detail von Boiserie mit Tabakfarbe gebeizt und "grigio Italia" Rauchglas umkleidet.

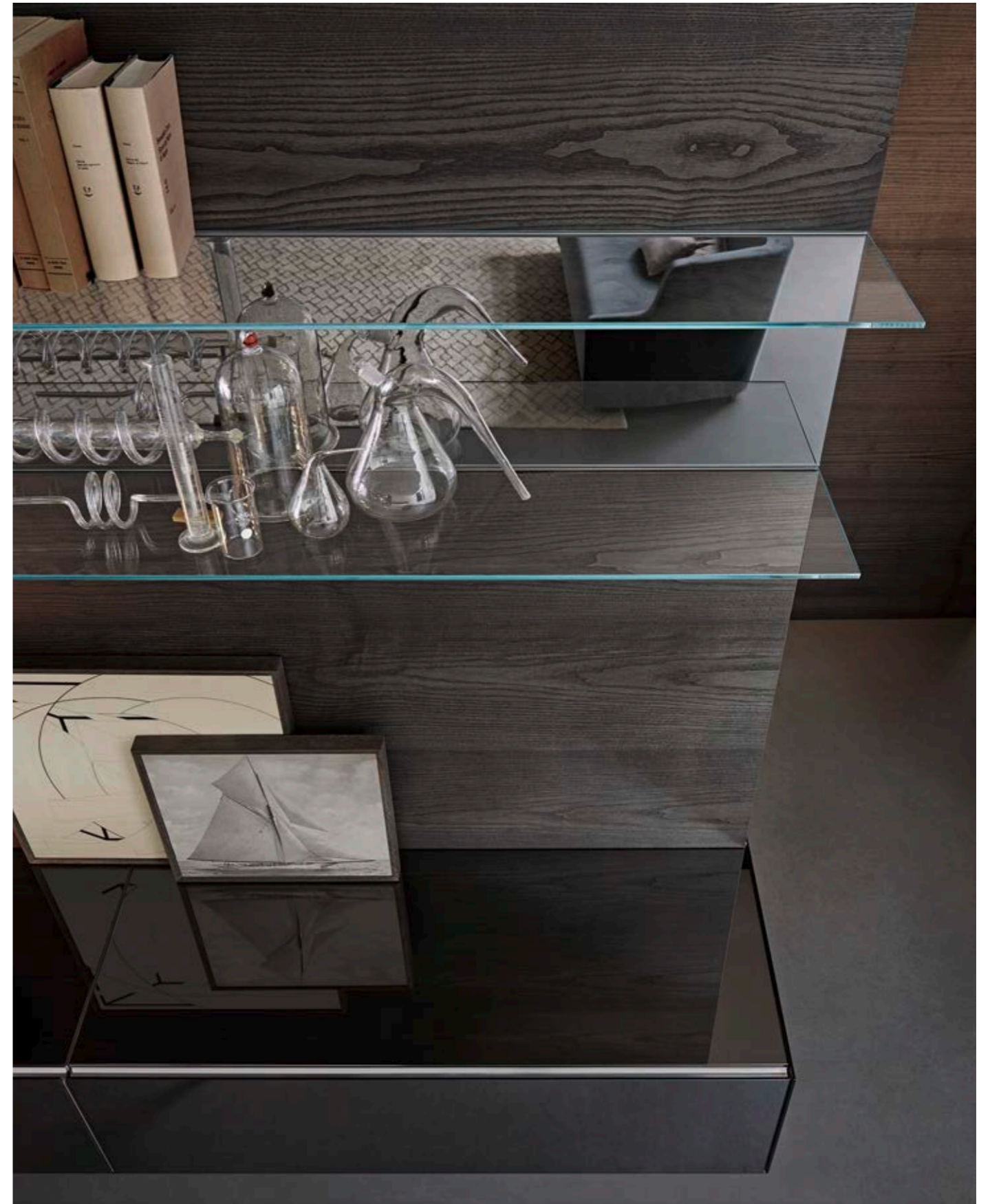

# Drizzle

Libreria modulare con struttura in alluminio anodizzato nei colori champagne o nero. Su richiesta set di montanti verticali colorati grigio, senape, rosso o rosa. Piani in cristallo trasparente extralight temperato 10 mm. Disponibile anche in cristallo "grigio Italia". A richiesta reggipiani in ottone satinato.

Shelving system with champagne or black anodised aluminium structure. Set of vertical lacquered supports in the colours grey, mustard, red or pink, on request. 10 mm extralight transparent tempered glass shelves. Available also smoked "grigio Italia" glass. Satin brass shelf supports, on request.

Bibliothèque modulaire avec montants en aluminium anodisé dans les couleurs champagne ou noir. Série de montants verticaux laqués dans les couleurs gris, moutarde, rouge ou rose. Tablettes en verre transparent extralight trempé de 10 mms d'épaisseur. Disponible aussi en verre "grigio Italia" fumé. Sur demande porte-tablettes en laiton satiné.

Regal in Modulbauweise. Träger eloxiertes Aluminium in den Farben champagne oder schwarz lackiert. Auf Wunsch Satzvertikalträger in den Farben grau, senffarben, rot oder rosa lackiert. Böden vorgespanntes Glas klar Extralight 10 mm. Lieferbar auch Rauchglas "grigio Italia". Auf Anfrage Bodenträger aus Messing satiniert.

> Libreria modulare da 100x37,5x191,5h cm con piani in cristallo trasparente extralight e struttura anodizzata nera con reggipiani in ottone satinato.

Shelving systems 100x37,5x191,5h cm with extralight transparent glass shelves and black anodised aluminium structure with satin brass shelf supports.

Bibliothèques modulaire de 100x37,5x191,5h cm avec tablettes en verre transparent extralight et structure en aluminium anodisé noir avec porte-tablettes en laiton satiné.

Regale in Modulbauweise von 100x37,5x191,5h cm mit Böden Glas klar Extralight und Träger Aluminium eloxiertes schwarz lackiert mit Bodenträger aus Messing satiniert.



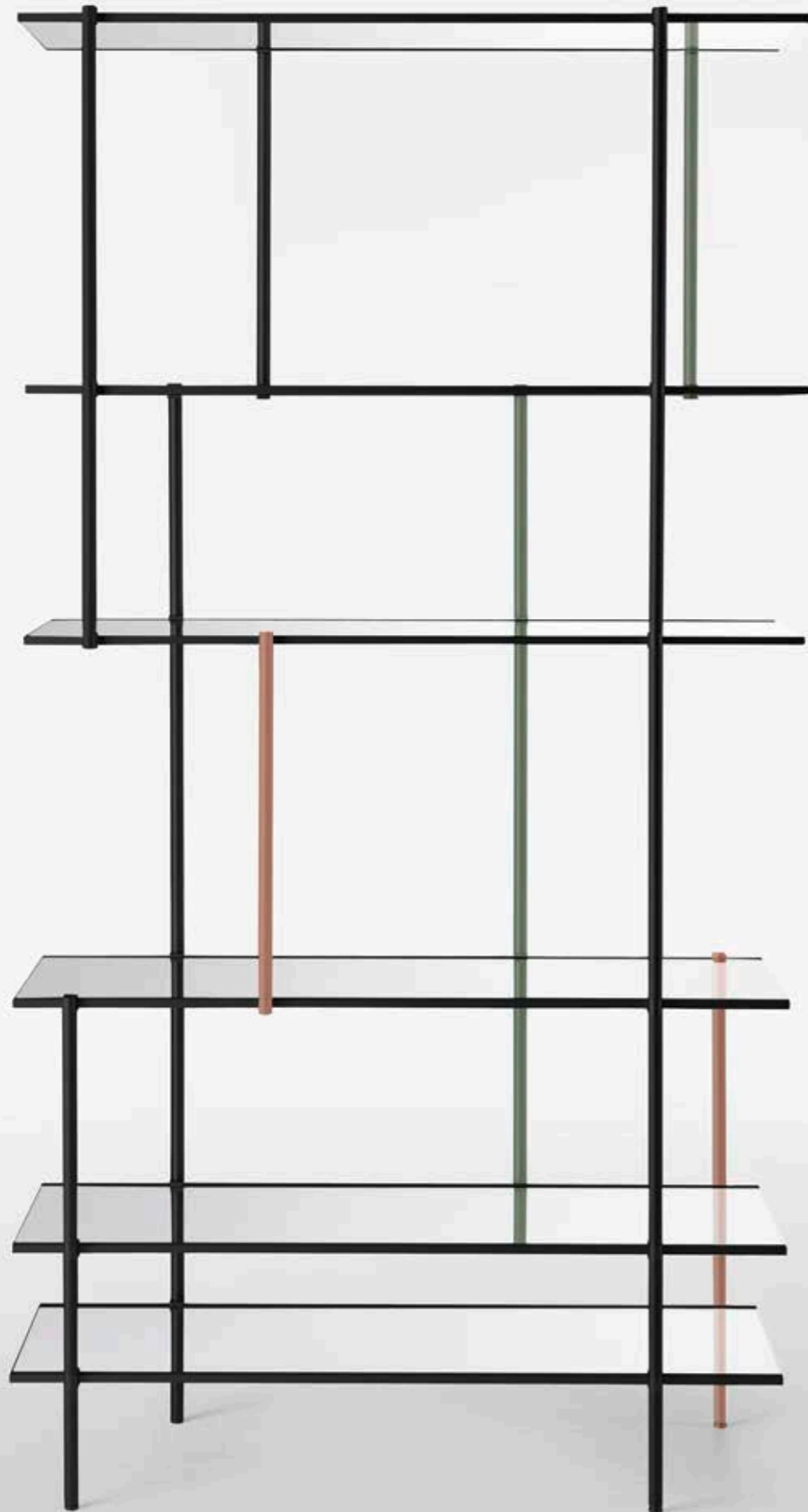

Shelving systems and Boiserie

< Libreria modulare da 100x37,5x191,5h cm con piani in cristallo trasparente extralight e struttura anodizzata nero con montanti colorati.

Shelving system 100x37,5x191,5h cm with extralight transparent glass shelves and black anodised aluminium structure with vertical coloured supports.

Bibliothèque modulaire de 100x37,5x191,5h cm avec tablettes en verre transparent extralight et structure en aluminium anodisé noir avec montants verticaux colorés.

Regal in Modulbauweise von 100x37,5x191,5h cm mit Böden Glas klar Extralight und Träger Aluminium eloxiertes schwarz lackiert mit farbigen Vertikalträger.

B-2 colours



A-3 colours



A-4 colours

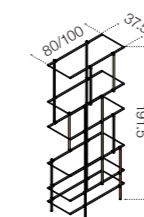
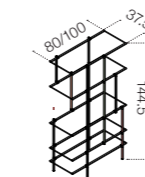
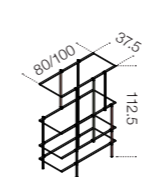
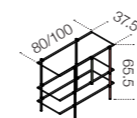

Cm (L x P x H)

80 x 37,5 x 65,5  
80 x 37,5 x 112,5  
80 x 37,5 x 144,5  
80 x 37,5 x 191,5  
100 x 37,5 x 65,5  
100 x 37,5 x 112,5  
100 x 37,5 x 144,5  
100 x 37,5 x 191,5

Inches (W x D x H)

31½" x 15" x 26"  
31½" x 15" x 44½"  
31½" x 15" x 57"  
31½" x 15" x 75½"  
39½" x 15" x 26"  
39½" x 15" x 44½"  
39½" x 15" x 57"  
39½" x 15" x 75½"

# Dipsy

Libreria modulare con montanti in acciaio inox lucido o satinato e piani in cristallo trasparente 10 mm. Disponibile con montanti in metallo brunito e piani in cristallo "grigio Italia" 10 mm. Parti in legno in rovere sbiancato, tinto wengé, tinto tabacco o laccato bianco o nero a poro aperto.

Shelving system with bright or satin stainless steel sides and 10 mm transparent glass shelves. Available with burnished metal sides and 10 mm smoked "grigio Italia" glass shelves. Whitened oak, wengé stained, tobacco stained or white or black open pore lacquered wooden parts.

Bibliothèque modulaire avec montants en acier inox brillant ou satiné et tablettes en verre transparent de 10 mms d'épaisseur. Disponible aussi avec montants en métal bruni et tablettes en verre "grigio Italia" fumé de 10 mms d'épaisseur. Parties en bois en chêne blanchi, teinté wengé, teinté tabac ou laqué blanc ou noir pore ouvert.

Regal in Modulbauweise. Träger Edelstahl (Inox) poliert oder gebürstet mit Glasböden 10 mm Klar. Lieferbar mit Träger Metall brüniert mit Glasböden Rauchglas "grigio Italia" 10 mm. Holzteile Eiche gebleicht, Wengé gebeizt, Tabakfarbe gebeizt, Lack weiss oder schwarz offenporig.

> Libreria da 124x44x194h cm con montanti in metallo brunito. Piani in cristallo trasparente extralight. Parti in legno in rovere tinto tabacco.

Shelving system of 124x44x194h cm with burnished metal sides. Extralight transparent glass shelves. Tobacco stained oak wooden parts.

Bibliothèque de 124x44x194h cm avec montants en métal bruni. Tablettes en verre transparent extralight. Parties en bois en chêne teinté tabac.

Regal 124x44x194h cm mit Träger Metall brüniert. Glasböden klar Extralight. Holzteile Eiche Tabakfarbe gebeizt.

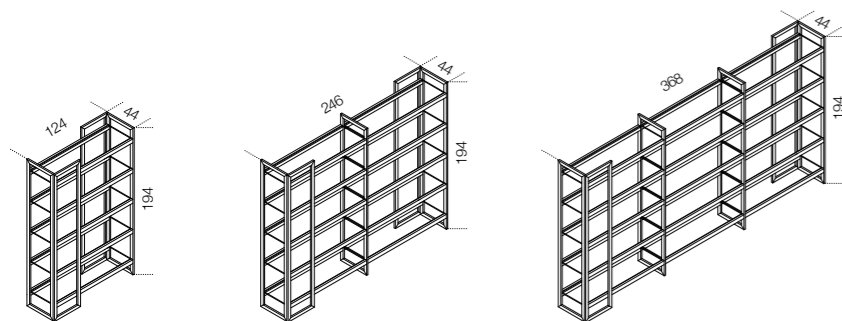

Cm (L x P x H)

124 x 44 x 194  
246 x 44 x 194  
368 x 44 x 194

Inches (W x D x H)

49" x 17½" x 76½"  
97" x 17½" x 76½"  
145" x 17½" x 76½"



# Tortona

Libreria in metallo verniciato bronzo patinato. Piani in cristallo 8 mm stopsol bronzo o trasparente extralight temperato.

Shelving system in patinated bronze lacquered metal. 8 mm bronze stopsol or extralight transparent tempered glass shelves.

Bibliothèque en métal laqué bronze patiné. Étagères en verre stopsol bronze ou transparent extralight trempé de 8 mm d'épaisseur.

Regal: Metall bronzenfarben patiniert lackiert. Glasböden 8 mm stopsol bronzenfarben oder klar Extralight vorgespannt.

> Libreria da 166x37x258h cm in metallo verniciato bronzo patinato. Piani in cristallo stopsol bronzo temperato.

Shelving system of 166x37x258h cm in patinated bronze lacquered metal. Bronze stopsol tempered glass shelves.

Bibliothèque de 166x37x258h cm en métal laqué bronze patiné. Étagères en verre stopsol bronze trempé.

Regal 166x37x258h cm aus Metall bronzenfarben patiniert lackiert. Glasböden stopsol bronzenfarben vorgespannt.

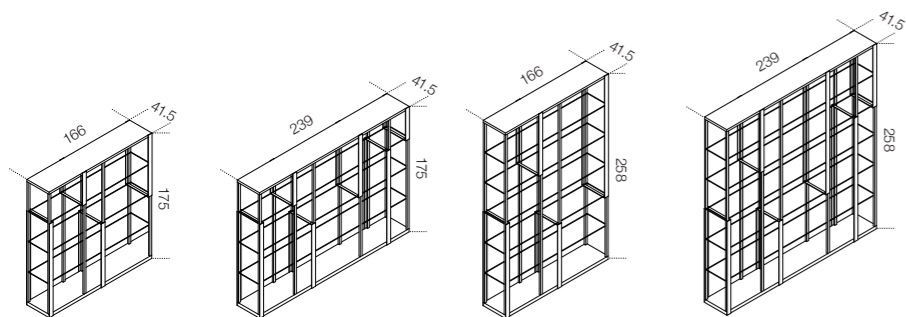

#### Cm (L x P x H)

166 x 37 x 175  
239 x 37 x 175  
166 x 37 x 258  
239 x 37 x 258

#### Inches (W x D x H)

65½" x 14¾" x 69"  
94¼" x 14¾" x 69"  
65½" x 14¾" x 101¾"  
94¼" x 14¾" x 101¾"



**Sedute e complementi/  
Seatings and accessories/  
Sièges et compléments/  
Sitzelemente und Einzelobjekte**

160 0414  
164 Bolle  
158 First  
156 Jackie  
154 OFX 09  
166 Tic Tac  
162 WGS Stool

# OFX 09

Sedia ufficio ergonomica. Seduta con scocca in legno imbottito e rivestito in pelle scamosciata o ecopelle nei colori del campionario. Schienale in 3 diverse altezze. Base girevole a 5 razze in alluminio pressofuso dotato di elevazione a gas, con ruote o finalini. Disponibile con braccioli cromati.

Ergonomic office chair. Upholstered wooden seat covered with suede or eco-leather as per samples. 3 different heights for backrest. Swivel five-star base made of die-cast aluminium. Gas lift height adjustment, with castors or feet. Available with chromed armrests.

Siège de bureau ergonomique. Assise en bois rembourrée et revêtue de simili cuir ou suédine dans les coloris de nos échantillons. Dossier à 3 positions de hauteurs différentes. Base pivotante à 5 pieds en aluminium moulé sous pression, système d'élévation à gaz, avec roulettes ou pieds. Disponible avec accoudoirs chromés.

Ergonomischer Bürostuhl. Sitz aus Holz gepolstert und mit Wildleder oder Spaltleder nach Musterkarte bezogen. Verstellbare Rückenlehne in 3 unterschiedlichen Höhen. Höhenverstellung mit Gasdruckfeder und Drehkreuzgestell mit 5 Rollen oder Füßchen. Auf Wunsch mit verchromten Armlehnen.

> Sedia ufficio 85h cm in pelle scamosciata Sand 06.

Office chair 85h cm in suede Sand 06.

Chaise de bureau 85h cm en suédine Sand 06.

Bürostuhl 85h cm Wildleder Sand 06.

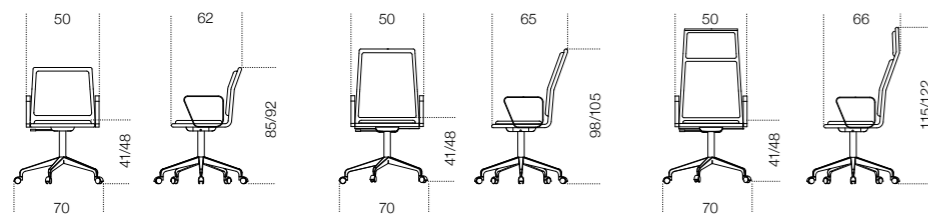

Cm (L x P x H)

50 x 62 x 85/92  
50 x 65 x 98/105  
50 x 66 x 115/122

Inches (W x D x H)

19 3/4" x 24 1/2" x 33 1/2"/36 1/4"  
19 3/4" x 25 3/4" x 38 3/4"/41 1/2"  
19 3/4" x 26" x 45 1/2"/48 1/4"



# Jackie

Poltroncina/Sedia imbottita completamente rivestita in tessuto Reggio o in pelle scamosciata nei colori del campionario.

Upholstered armchair/ chair completely covered by fabric Reggio or suede as per samples.

Petite fauteuil rembourrée avec accoudoirs entièrement revêtue de tissu Reggio ou suédine dans les coloris de nos échantillons. Disponible sans accoudoirs.

Polsterarmstuhl/-stuhl ganz mit Stoffe in der Farbe Reggio oder Wildleder bezogen. Lieferbare Farben nach Musterkarte.

> Poltroncina imbottita completamente rivestita in tessuto Reggio.

Upholstered armchair completely covered by fabric Reggio.

Petite fauteuil rembourrée avec accoudoirs entièrement revêtue de tissu Reggio.

Polsterarmstuhl ganz mit Stoffe in der Farbe Reggio.

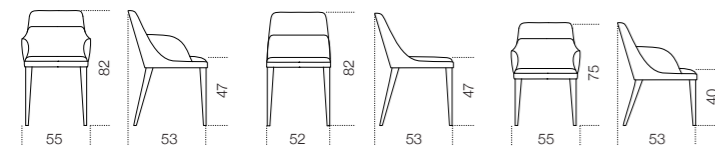

Cm (L x P x H)

55 x 52 x 79

55 x 52 x 72

Lounge

Inches (W x D x H)

21 3/4" x 20 1/2" x 31 1/4"

21 3/4" x 20 1/2" x 28 1/2" Lounge





# First

Divano in poliuretano espanso indeformabile a densità differenziate e fibra poliestere con struttura interna in legno. Piedi in legno laccato nero. Cuscini in fibra poliestere. Disponibile con rivestimento in velluto o pelle scamosciata nei colori del campionario.

Sofa in non-deformable foam polyurethane in different density and polyester fibre with wooden inside structure. Black lacquered wooden feet. Polyester fibre cushions. Available covered by velvet or suede as per samples.

Canapé en polyurethane expansé indéformable en densité variables et fibre de polyester avec structure à l'intérieur en bois. Pieds en bois laqué noir. Coussins en fibre de polyester. Disponible avec revêtement en velours ou suédine dans les coloris de nos échantillons.

Sofa aus unverformbarem Polyurethanschaum mit unterschiedlicher Dichte und Polyesterfaser mit Innengestell Holz. Füße Holz schwarz lackiert. Kissen aus Polyesterfaser. Lieferbar mit Samt oder Wildleder in den Farben nach Musterkarte bezogen.

> Divano con rivestimento in velluto Taupe 537

Sofa covered by Taupe 537.

Canapé revêtu en velours Taupe 537.

Sofa mit Samt Taupe 537 bezogen.

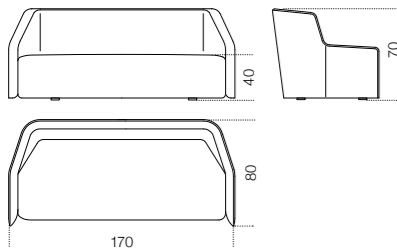

Cm (L x P x H)  
170 x 80 x 70

Inches (W x D x H)  
67" x 31½" x 27¾"



# 0414

Poltroncina con struttura in frassino tinto tabacco o frassino naturale. Disponibile anche laccato nero o bianco poro aperto (Mod. Layer). Seduta e schienale rivestiti in pelle scamosciata o in velluto nei colori del campionario.

Armchair with tobacco stained or natural ash structure. Available also with black or white open pore lacquered (Mod. Layer) structure. Seat and backrest covered by suede or velvet as per samples.

Petite fauteuil avec structure en frêne teinté tabac ou frêne naturel. Disponible aussi laqué noir ou blanc pore ouverts (Mod. Layer). Siège et dossier revêtus de suédine ou velours dans les coloris de nos échantillons.

Armstuhl mit Gestell Eschenholz Tabakfarbe gebeizt oder Eschenholz natur. Lieferbar auch lackiert schwarz oder weiss offenporig (Mod. Layer). Sitz und Rückenlehne mit Wildleder oder Samt bezogen. Lieferbare Farben nach Musterkarte.

> Poltroncina con struttura in frassino laccato nero. Seduta e schienale rivestiti in velluto blue 408.

Armchair with black lacquered ash structure. Seat and backrest covered by blue 408 velvet.

Petite fauteuil avec structure en frêne laqué noir. Siège et dossier revêtu de velours blue 408.

Armstuhl mit Gestell Eschenholz lackiert schwarz. Sitz und Rückenlehne mit Samt blue 408 bezogen.

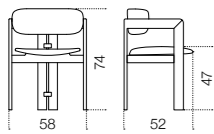

Cm (L x P x H)  
58 x 52 x 74

Inches (W x D x H)  
23" x 20½" x 29¼"



# WGS Stool

Sgabello in acciaio inox lucido oppure in metallo laccato bianco goffrato, grigio alluminio o color ottone satinato rivestito in feltro, cuoio, pelle scamosciata, tessuto outdoor (Clivia, Corbezzolo, Narciso) o velluto nei colori del campionario.

Bright stainless steel or embossed white, grey aluminium or satin brass colour lacquered metal stool, covered by felt, leather, suede, outdoor fabric (Clivia, Corbezzolo, Narciso) or velvet as per samples.

Tabouret en acier inox brillant ou en metal laqué blanc gaufré, gris aluminium ou couleur laiton satiné recouvert de feutre, cuir, suédine, tissu pour outdoor (Clivia, Corbezzolo, Narciso) ou velours dans les coloris de nos échantillons.

Hocker aus Edelstahl (Inox) poliert oder Metall Lack weiss strukturlakkiert, Aluminium grau oder Messing-Farbe satiniert, mit Filz, Leder, Wildleder, Outdoor-Stoff (Clivia, Corbezzolo, Narciso) oder Samt bezogen. Lieferbare Farben nach Musterkarte.

> Sgabelli in acciaio inox rivestiti in tessuto outdoor Clivia e Narciso.

Stainless steel stools covered by Clivia and Narciso outdoor fabric.

Tabourettes en acier inox recouvert de tissu Clivia et Narciso pour outdoor.

Hocker aus Edelstahl (Inox) mit Clivia und Narciso Outdoor-Stoffe bezogen.

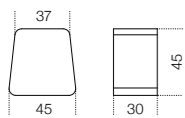

Cm (L x P x H)  
45 x 30 x 45

Inches (W x D x H)  
17¾" x 12" x 17¾"



# Bolle

Lampada a sospensione a luce alogena puntiforme (120 Watt). Sfere in cristallo trasparente soffiato a bocca. Parti metalliche in ottone brunito a mano. L'ottone risulta naturalmente macchiato e disomogeneo. Questa lavorazione artigianale conferisce ad ogni pezzo una particolare unicità, rendendolo esclusivo. \*Disponibile in versioni personalizzate.

Hanging lamp with halogen point light (120 Watt). Transparent blown glass balls. Metal parts in hand burnished brass. The hand burnished brass finish looks naturally spotted and irregular. Due to this craft-made processing, each product is unique and exclusive. \*Available in customized versions.

Lampe à suspension avec lumière halogène ponctuelle (120 Watt). Boules en verre soufflé transparent. Parties métalliques en laiton bruni à la main. Le laiton bruni à la main est naturellement taché et pas uniforme. Ce travail artisanal du laiton confère à chaque pièce un caractère unique la rendant exceptionnelle. \*Disponible en versions personnalisées.

Pendellampe mit Halogen punktförmiger Lichtquelle (120 Watt). Geblasenes Klarglasbälle. Metallteile Messing handbruniert. Die Messingoberfläche erscheint fleckig und ungleich. Diese handwerkliche Bearbeitung gibt jedoch jedem einzelnen Stück eine exklusive Einzigartigkeit. \*Lieferbar in Sonderausführungen.

> Composizione di 3 lampade in altezza speciale.

Composition of 3 lamps in special height.

Composition de 3 lampes en hauteur spéciale.

Komposition mit 3 Lampe in Sonderhöhe.

Cm (L x P x H)  
90 x 80 x 115

Inches (W x D x H)  
35½" x 31½" x 45½"

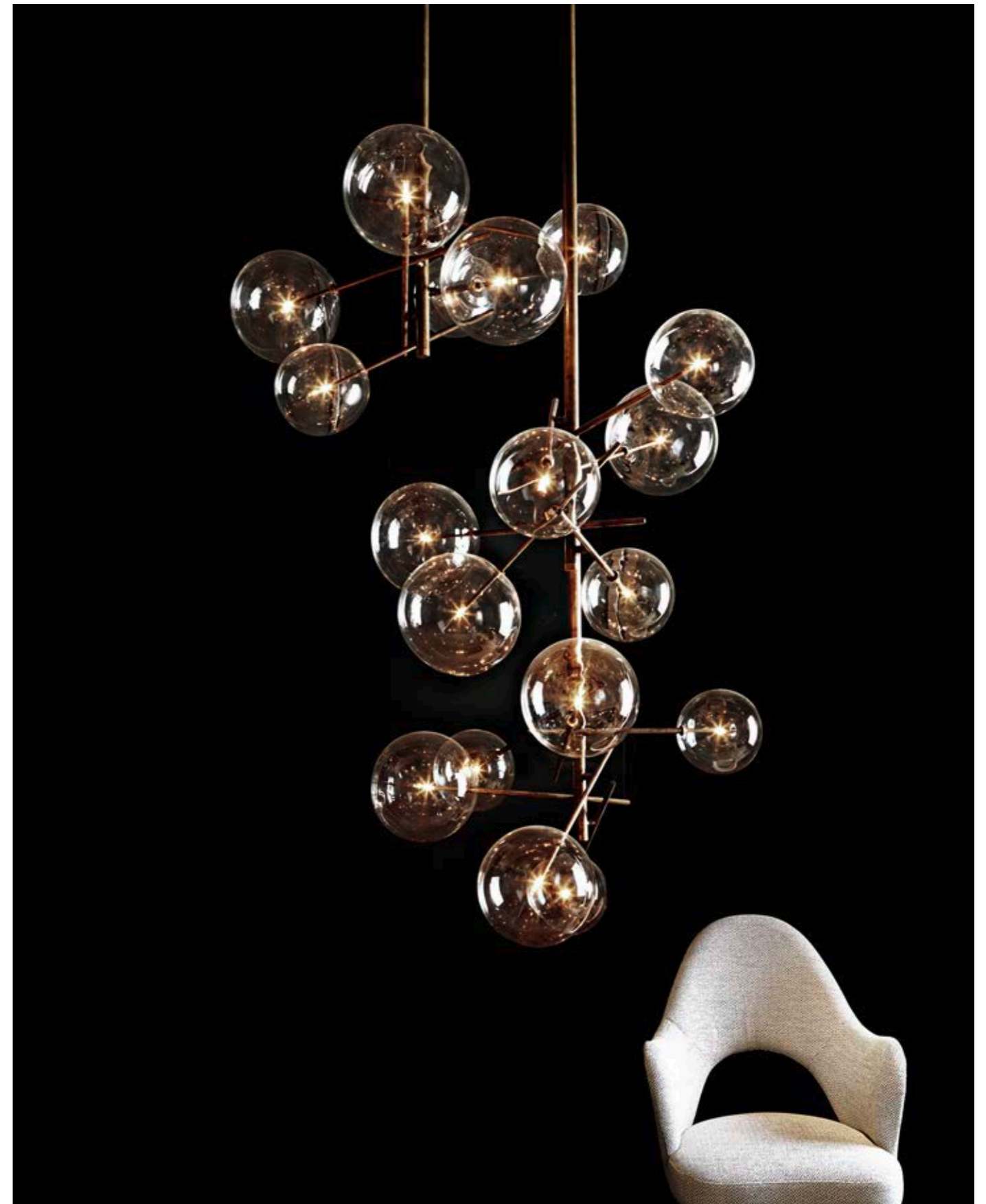
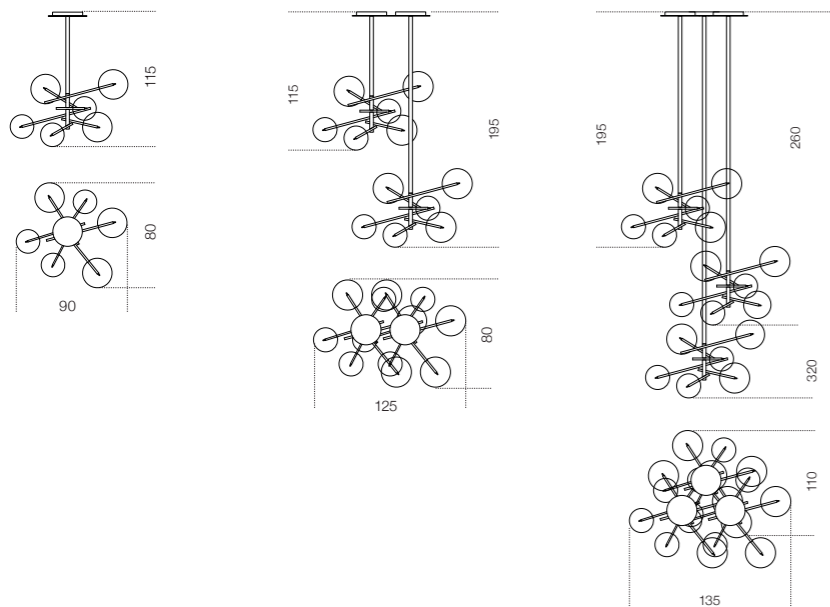

# Tic Tac

Orologio a pendolo con caricamento manuale. Struttura in frassino tinto tabacco e frontale in cristallo trasparente extralight 6 mm temperato e bisellato. Fondo in acciaio inox lucido "supermirror". Meccanismo in alluminio anodizzato nero e ottone cromato. Orologio con funzione a batteria.

Manual winding pendulum clock. Tobacco stained ash structure and 6 mm extralight transparent tempered bevelled front glass. "Supermirror" bright stainless steel back. Black anodised aluminium and chromed brass mechanism. Striking mechanism clock.

Pendule à chargement manuel. Panneau en frêne teinté tabac et devant en verre transparent extralight de 6 mms d'épaisseur trempé biseauté. Fond en acier inox brillant "supermirror". Mécanisme en aluminium anodisé noir et laiton chromé. Mécanisme de l'horloge par batterie.

Handaufzugpendeluhr: Holzteile Eschenholz Tabakfarbe gebeizt und vorgespannte Glasfront klar Extralight 6 mm mit Facettschliff. Rückteil "Supermirror" Edelstahl (Inox) poliert. Uhrwerk eloxiertes Aluminium schwarz und Messing verchromt. Batterieuhr.

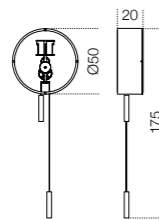

Cm (L x P x H)  
ø 50 x 20 x 175h

Inches (W x D x H)  
ø 1 9/16" x 8" x 6 9/16"

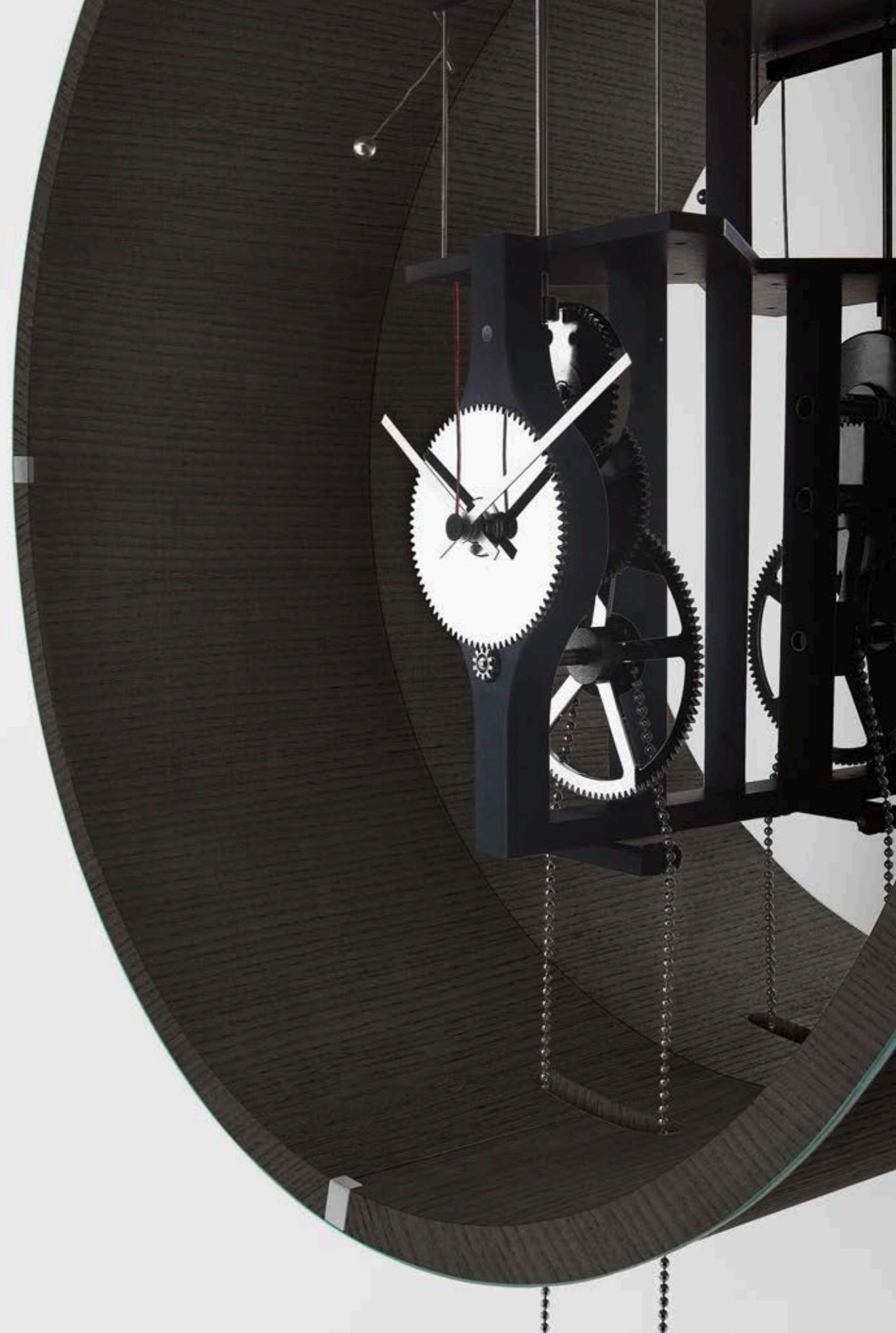

# Tavoli riunione/ Conference tables/ Tables de conférence/ Konferenztische

214	Adam
182	Air Table
166	Akim
206	Big Basic
184	Carlomagno
172	Dolm
198	Eros
212	Ever
178	Koy
188	Lord
195	Raj
204	Ra Fx
208	Smart
192	Still
216	Supercalif...
202	Upside 14
204	Upside
210	Yan

# Akim

Tavolo con piano in cristallo trasparente extralight 15 mm, retroverniciato solo nella parte centrale, nei colori del campionario, nella versione brillante. Basi in legno rivestite in cristallo retroverniciato. Su richiesta può essere dotato di sistema passacavi. Akim si presta per composizioni modulari, anche in dimensioni speciali (Akim System).

Table with 15 mm extralight transparent glass top, painted only in the middle part, as per samples in the bright version. Wooden base covered by painted glass. Available with cable management, on request. Akim is suitable for modular compositions also in customized sizes (Akim System).

Table avec plateau en verre transparent extralight de 15 mm d'épaisseur, verni seulement au milieu dans les coloris de nos échantillons dans la version brillante. Piètement en bois recouvert de verre verni. Sur demande disponible avec système pour le passage des câbles. Akim est destiné à des compositions modulables aussi en dimensions spéciales (Akim System).

Tisch: Glasplatte Klar Extralight 15 mm, in der Mitte hochglanz lackiert nach Musterkarte. Gestell Holz mit lackiertem Glas nach Musterkarte umkleidet. Auf Wunsch lieferbar auch mit Kabeldurchlass. Akim kann in modularer Weise, auch in Sondermassen verwendet werden (Akim System).

> Composizione di tavoli 600x120x74h cm con piani in cristallo trasparente extralight e parte centrale retroverniciata blu grigio brillante. Dotato di sistema passacavi. Base rivestita in cristallo retroverniciato blu grigio brillante. Sedie OFX 09 h85 cm in pelle scamosciata Sand 06. Lampada Bolle in altezza speciale.

Tables composition 600x120x74h cm with extralight transparent glass tops and bright blue grey painted middle part. Supplied with cable management. Base covered by bright blue grey painted glass. Chairs OFX 09 h85 cm in suede Sand 06. Lamp Bolle with special height.

Composition de tables 600x120x74h cm avec plateaux en verre transparent extralight et partie centrale vernie blue gris brillant. Avec système pour le passage des câbles. Piètement recouvert en verre verni blue gris brillant. Chaises OFX 09 h85 cm en suède Sand 06. Lampe Bolle avec hauteur spéciale.

Tischezusammenstellung 600x120x74h cm mit Glasplatte klar Extralight und in der Mitte Glas blau grau hochglänzend lackiert. Mit Kabeldurchlass. Gestell mit blau grau hochglänzendem Glas umkleidet. Stühle OFX 09 h85 cm Wildleder Sand 06. Lampe Bolle in Sonderhöhe.







Akim

Cm (L x P x H)	Inches (W x D x H)
240 x 120 x 74	94½" x 47¼" x 29¼"
260 x 120 x 74	102½" x 47¼" x 29¼"
280 x 120 x 74	110¼" x 47¼" x 29¼"
300 x 120 x 74	118¼" x 47¼" x 29¼"
320 x 120 x 74	126" x 47¼" x 29¼"
240 x 130 x 74	94½" x 51¼" x 29¼"
260 x 130 x 74	102½" x 51¼" x 29¼"
280 x 130 x 74	110¼" x 51¼" x 29¼"
300 x 130 x 74	118¼" x 51¼" x 29¼"
320 x 130 x 74	126" x 51¼" x 29¼"

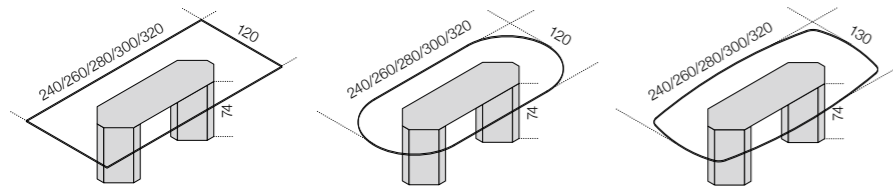

Akim system

Cm (L x P x H)	Inches (W x D x H)
440 x 120 x 74	173¼" x 47¼" x 29¼"
480 x 120 x 74	189" x 47¼" x 29¼"
520 x 120 x 74	204¾" x 47¼" x 29¼"
560 x 120 x 74	220½" x 47¼" x 29¼"
600 x 120 x 74	236¼" x 47¼" x 29¼"
640 x 120 x 74	252" x 47¼" x 29¼"

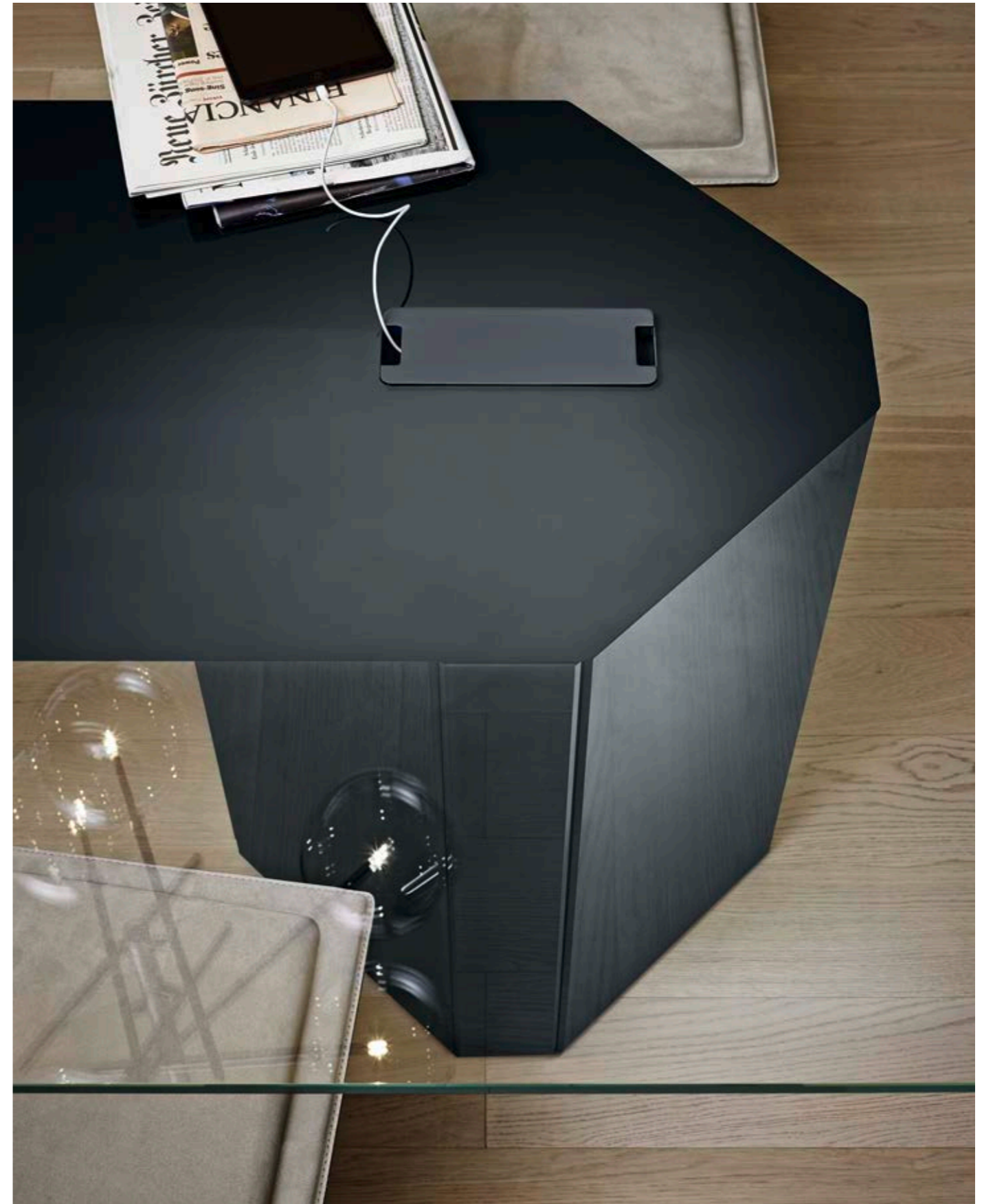
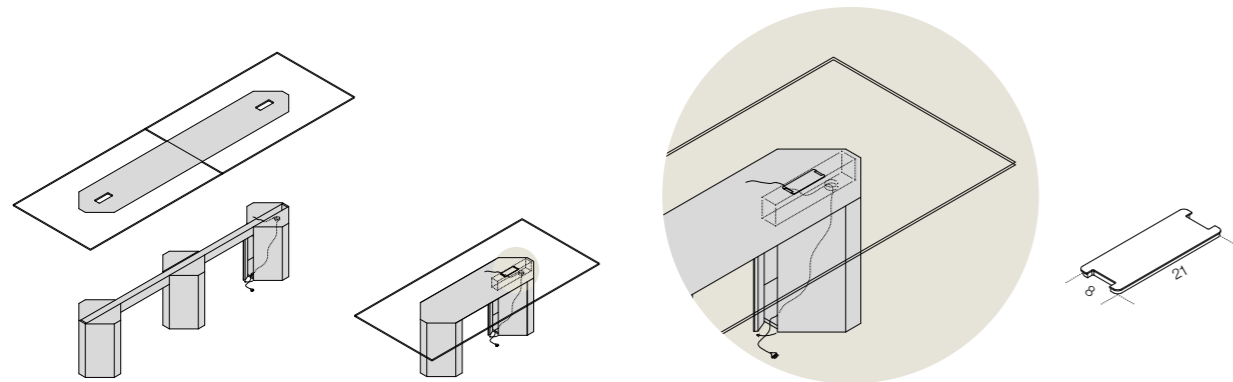
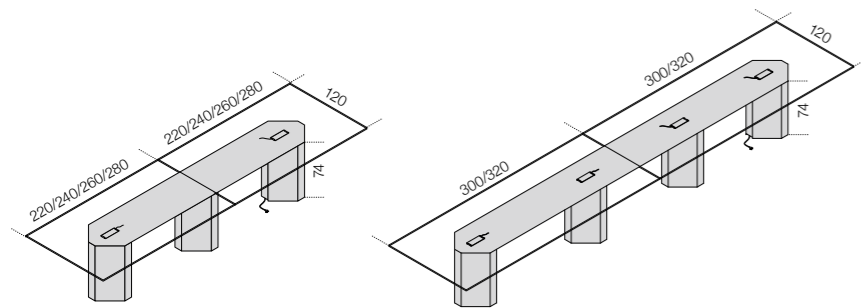

# Dolm

Tavolo con piano in cristallo trasparente extralight 15 mm, retroverniciato solo nella parte centrale nei colori del campionario nella versione brillante. Piano con bisello a 45°. Basi in legno rivestito in cristallo retroverniciato. Su richiesta puo' essere dotato di passacavi. Dolm si presta per composizioni modulari, anche in dimensioni speciali (Dolm System).

Table with 15 mm extralight transparent glass top, painted only in the middle part as per samples in the bright version. 45° bevelled glass top. Wooden base covered by painted glass. Available with cable management, on request. Dolm is suitable for modular compositions also in customized sizes (Dolm System).

Table avec plateau en verre transparent extralight de 15 mm d'épaisseur, verni seulement au milieu dans les coloris de nos échantillons dans la version brillante. Plateau biseauté à 45°. Piètement en bois recouvert de verre verni. Sur demande disponible avec système pour le passage des câbles. Dolm est destiné à des compositions modulables aussi en dimensions spéciales (Dolm System).

Tisch: Glasplatte Klar Extralight 15 mm, in der Mitte hochglanz lackiert nach Musterkarte. Glas mit 45° Facettschliff. Gestell Holz mit lackiertem Glas umkleidet. Auf Wunsch lieferbar auch mit Kabeldurchlass. Dolm kann in modularer Weise, auch in Sondermassen verwendet werden (Dolm System).

> Composizione di tavoli 400x120x74h cm con piani in cristallo trasparente extralight bisellato e parte centrale retroverniciata grigio beige brillante. Base rivestita in cristallo retroverniciato grigio beige brillante. Dotato di sistema passacavi. Sedie OFX 09 h85 cm in pelle scamosciata Sand 012. Composizione Air Unit pensile da 362x51x74h cm (tre moduli U02R da 120 cm) rivestita in cristallo grigio beige satinato. Tic Tac 14 orologio tinto tabacco.

Tables composition 400x120x74h cm with extralight transparent bevelled glass tops and bright taupe painted middle part. Base covered by bright taupe painted glass. Supplied with cable management. Chairs OFX 09 h85 cm in suede Sand 012. Air Unit suspended composition 362x51x74h cm (three units U02R of 120 cm) covered by satin taupe painted glass. Tic Tac 14 clock tobacco stained.

Composition de tables 400x120x74h cm avec plateaux en verre transparent extralight biseauté et partie centrale verni taupe brillant. Avec système pour le passage des câbles. Piètement recouvert en verre verni taupe brillant. Chaises OFX 09 h85 cm en suède Sand 012. Composition murale Air Unit de 362x51x74h cm (trois meubles U02R de 120 cm) recouvert de verre verni taupe satiné. Tic tac 14 horloge teinté tabac.

Tischezusammenstellung 400x120x74h cm mit Glasplatte klar Extralight mit Facettschliff und in der Mitte Glas beige-grau hochglänzend lackiert. Mit Kabeldurchlass. Gestell mit beige-grau hochglänzendem Glas umkleidet. Stühle OFX 09 h85 cm Wildleder Sand 012. Hänge-Komposition Air Unit 362x51x74h cm (drei Elementen U02R 120 cm) mit beige-grau matt satiniertem lackiertem Glas umkleidet. Tic Tac 14 Pendeluhr Tabakfarbe gebeizt.





Dolm

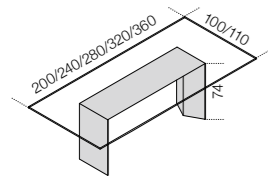

Cm (L x P x H)	Inches (W x D x H)
200 x 100 x 74	78¾" x 39½" x 29¼"
240 x 100 x 74	94½" x 39½" x 29¼"
280 x 110 x 74	110¼" x 43½" x 29¼"
320 x 110 x 74	126" x 43½" x 29¼"
360 x 110 x 74	141¾" x 43½" x 29¼"

Dolm.System

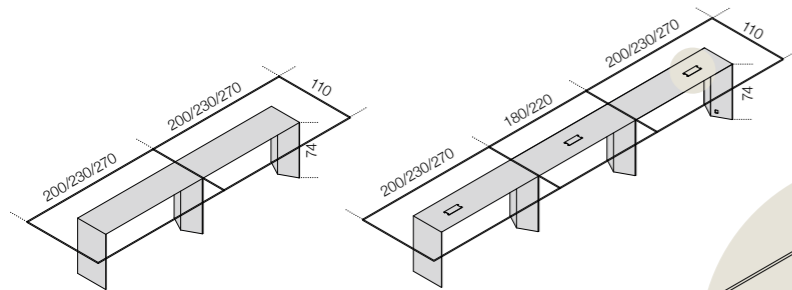

Cm (L x P x H)	Inches (W x D x H)
400 x 110 x 74	157½" x 43½" x 29¼"
460 x 110 x 74	181¼" x 43½" x 29¼"
540 x 110 x 74	212¾" x 43½" x 29¼"
580 x 110 x 74	228½" x 43½" x 29¼"
640 x 110 x 74	252" x 43½" x 29¼"
760 x 110 x 74	299¼" x 43½" x 29¼"

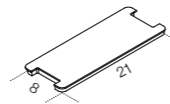
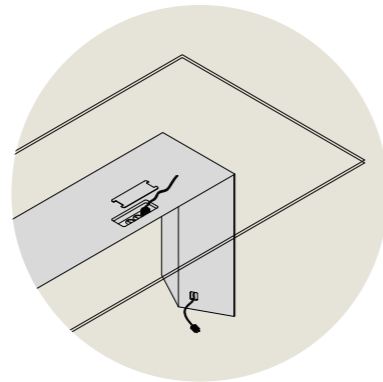

# Koy

Tavolo con struttura in alluminio rivestito in rovere tinto tabacco o tinto wengé. Disponibile anche laccato bianco o nero goffrato o laccato effetto tessuto nei colori castagna, sabbia e canapa. Piano in cristallo trasparente o "grigio Italia" 12 mm. Su richiesta retroverniciato nei colori del campionario nella versione brillante o satinata. Su richiesta può essere dotato di sistema passacavi. Koy si presta per composizioni modulari (Koy System).

Table with aluminium structure covered by tobacco stained oak or wengé stained oak. Available also embossed white or black or with "fabric" touch effect in the colours chestnut, sand and canapa lacquered structure. 12 mm transparent or smoked "grigio Italia" glass top. Painted glass as per samples in the bright or satin version, on request. Available with cable management, on request. Koy is suitable for modular compositions (Koy System).

Table avec structure en aluminium recouvert de chêne teinté tabac ou teinté wengé. Disponible aussi laqué blanc ou noir gaufré ou laqué avec effet tissu dans les coloris châtaigne, sablé ou chanvre. Plateau en verre transparent ou "grigio Italia" fumé de 12 mms d'épaisseur. Sur demande verni dans les coloris de nos échantillons dans la version brillante ou satinée. Sur demande disponible avec système pour le passage des câbles. Koy est destiné à des compositions modulables (Koy System).

Tisch: Aluminiumgestell mit Eiche Tabakfarbe oder Wengé gebeizt umkleidet. Lieferbar auch weiss oder schwarz strukturlackiert oder lackiert mit Stoff-Effekt in kastanienbraun, sandfarben und hanffarben. Glasplatte klar oder Rauchglas "grigio Italia" 12 mm. Auf Wunsch Glas lackiert nach Musterkarte. Lackierung jeweils hochglanz oder matt satiniert. Der Tisch kann mit Kabeldurchlass geliefert werden. Koy kann in modularer Weise verwendet werden (Koy System).

> Tavolo extralarge da 300 x110 cm con due piani in cristallo extralight e struttura laccata canapa effetto tessuto.

Table extralarge with two extralight glass tops 300 x110 cm and canapa lacquered wooden structure with "fabric" touch effect.

Table extralarge avec deux plateaux en verre extralight de 300x110 cm et structure laquée chanvre avec effet tissu.

Tisch Extralarge mit zwei Glasplatten Extralight von 300x110 cm und Gestell Holz hanffarben lackiert mit Stoffe-Effekt.

Koy

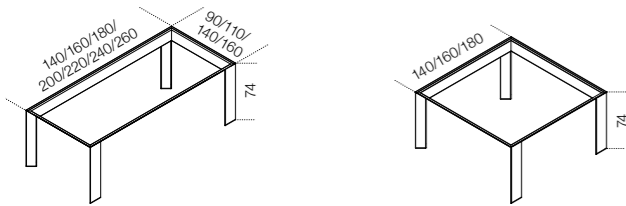

KoySystem

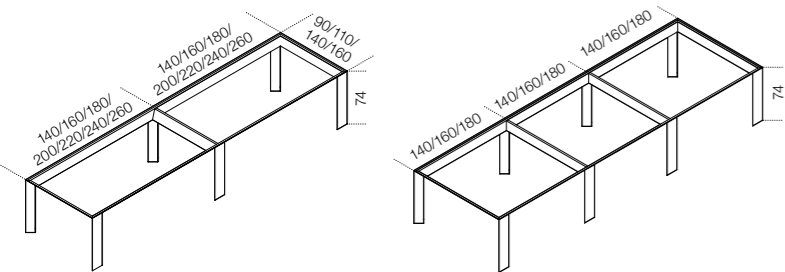

## Cm (L x P x H)

140 x 90 x 74	<input type="checkbox"/>
160 x 90 x 74	<input type="checkbox"/>
180 x 90 x 74	<input type="checkbox"/>
200 x 90 x 74	<input type="checkbox"/>
220 x 90 x 74	<input type="checkbox"/>
140 x 110 x 74	<input type="checkbox"/>
160 x 110 x 74	<input type="checkbox"/>
180 x 110 x 74	<input type="checkbox"/>
200 x 110 x 74	<input type="checkbox"/>
220 x 110 x 74	<input type="checkbox"/>
240 x 110 x 74	<input type="checkbox"/>
260 x 110 x 74	<input type="checkbox"/>
160 x 140 x 74	<input type="checkbox"/>
180 x 140 x 74	<input type="checkbox"/>
180 x 160 x 74	<input type="checkbox"/>
140 x 140 x 74	<input type="checkbox"/>
160 x 160 x 74	<input type="checkbox"/>
180 x 180 x 74	<input type="checkbox"/>

## Inches (W x D x H)

55¼" x 35½" x 29¼"	<input type="checkbox"/>
63" x 35½" x 29¼"	<input type="checkbox"/>
71" x 35½" x 29¼"	<input type="checkbox"/>
78¾" x 35½" x 29¼"	<input type="checkbox"/>
86¾" x 35½" x 29¼"	<input type="checkbox"/>
55¼" x 43½" x 29¼"	<input type="checkbox"/>
63" x 43½" x 29¼"	<input type="checkbox"/>
71" x 43½" x 29¼"	<input type="checkbox"/>
78¾" x 43½" x 29¼"	<input type="checkbox"/>
86¾" x 43½" x 29¼"	<input type="checkbox"/>
94½" x 43½" x 29¼"	<input type="checkbox"/>
102½" x 43½" x 29¼"	<input type="checkbox"/>
63" x 55¼" x 29¼"	<input type="checkbox"/>
71" x 55¼" x 29¼"	<input type="checkbox"/>
71" x 63" x 29¼"	<input type="checkbox"/>
55¼" x 55¼" x 29¼"	<input type="checkbox"/>
63" x 63" x 29¼"	<input type="checkbox"/>
71" x 71" x 29¼"	<input type="checkbox"/>





# Air Table

Tavolo in cristallo trasparente o "grigio Italia" temperato 12 mm. Disponibile con piano retroverniciato nei colori del campionario nella versione brillante o satinata. Parti metalliche in acciaio inox lucido, satinato oppure alluminio anodizzato, laccato bianco o nero goffrato. Su richiesta alluminio spazzolato a mano nei colori nero o titanio.

Table in 12 mm transparent or smoked "grigio Italia" tempered glass. Available also with painted glass top as per samples in the bright or satin version. Bright or satin stainless steel, anodised aluminium or embossed metal parts. Hand brushed aluminium in the colours black or titanium grey, on request.

Table en verre transparent ou "grigio Italia" fumé trempé de 12 mms d'épaisseur. Disponible aussi avec plateau en verre verni dans les coloris de nos échantillons dans la version brillante ou satinée. Parties métalliques en acier inox brillant, satiné ou en aluminium anodisé, laqué blanc ou noir gaufré. Sur demande aluminium brossé à la main dans les coloris noir ou gris titane.

Tisch: vorgespanntes Glas klar oder Rauchglas "grigio Italia" 12 mm. Lieferbar mit Glasplatte lackiert nach Musterkarte. Lackierung jeweils hochglanz oder matt satiniert. Metallteile Edelstahl (Inox) poliert, gebürstet oder eloxiertes Aluminium oder weiss oder schwarz strukturlackiert. Lieferbar auch Aluminium handgebürstet in den Farben schwarz oder titangrau.

▼ Tavolo con piano in cristallo trasparente extralight da 280x90 cm e parti metalliche in acciaio inox lucido. Sedie OFX 09 h85 cm in ecopelle bianca.

Table with extralight transparent glass top 280x90 cm and bright stainless steel metal parts. Chairs OFX 09 h85 cm in white eco-leather.

Table avec plateau en verre transparent extralight de 280x90 cm et parties métalliques en acier inox brillant. Chaises OFX 09 h85 cm en simili cuir blanc.

Tisch mit Glasplatte klar Extralight von 280x90 cm und Metallteile Edelstahl (Inox) poliert. Stühle OFX 09 h85 cm Spaltleder weiss.

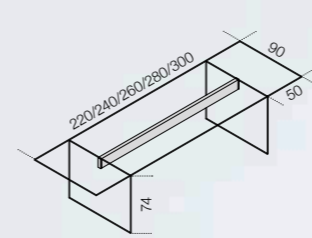

Cm (L x P x H)

220 x 90 x 74  
240 x 90 x 74  
260 x 90 x 74  
280 x 90 x 74  
300 x 90 x 74

Inches (W x D x H)

86¼" x 35½" x 29¼"  
94½" x 35½" x 29¼"  
102½" x 35½" x 29¼"  
110½" x 35½" x 29¼"  
118¼" x 35½" x 29¼"



# Carlomagno

Tavolo con piano in cristallo trasparente 15 mm. A richiesta retroverniciato nei colori del campionario, nella versione brillante o satinata. Struttura in acciaio inox lucido (profilo 40x20x2 mm). Disponibile anche in acciaio inox satinato o in acciaio laccato bianco o nero goffrato. Per le versioni XL da 260x110 cm il piano è sempre in cristallo trasparente 19 mm. Struttura (profilo 50x25x3 mm) in acciaio inox lucido o satinato. Su richiesta si realizzano piani con dimensioni speciali.

Table with 15 mm transparent glass top. Painted glass as per samples in the bright or satin version, on request. Structure in bright stainless steel (40x20x2 mm). Available also in satin stainless steel or embossed white or black lacquered steel. For the XL versions, from 260x110 cm, the top is always in 19 mm transparent glass. Bright or satin stainless steel structure (50x25x3 mm). Customized sizes for the top on request.

Table avec plateau en verre transparent de 15 mms d'épaisseur. Sur demande aussi en verre verni dans les coloris de nos échantillons dans la version brillante ou satinée. Structure en acier inox brillant (40x20x2 mm). Disponible aussi en acier inox satiné ou en acier laqué blanc ou noir gaufré. Pour les versions XL, à partir de 260x110 cm, le plateau est toujours transparent de 19 mms d'épaisseur. Structure (50x25x3 mm) en acier inox brillant ou satiné. Sur demande il est possible de réaliser plateaux en dimensions spéciales.

Tisch: Glasplatte 15 mm klar. Glas lieferbar auch lackiert nach Musterkarte. Lackierung jeweils hochglanz oder matt satiniert. Gestell Edelstahl (Inox) poliert (Profilmasse 40x20x2 mm). Auf Wunsch auch Edelstahl (Inox) gebürstet oder weiss oder schwarz strukturlackiert. Für die XL-Ausführungen, ab 260 x110 cm, ist die Glasplatte immer klar 19 mm. Gestell (Profilmasse 50 x25x3 mm) Edelstahl (Inox) poliert oder gebürstet. Auf Anfrage Glasplatte auch in Sondergrößen lieferbar.

> Tavolo con piano in cristallo trasparente da 240x100 cm e struttura in acciaio inox lucido.

Table with 240x100 cm transparent glass top and bright stainless steel structure.

Table avec plateau en verre transparent de 240x100 cm et structure en acier inox brillant.

Tisch mit Klarglasplatte 240x100 cm und Gestell aus Edelstahl (Inox) poliert.

Carlomagno

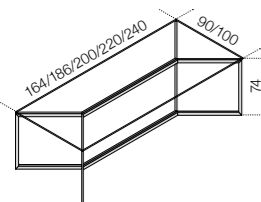

Carlomagno XL

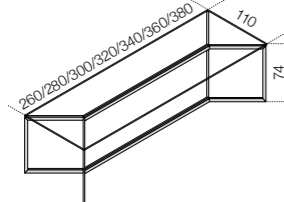

Glass	mm	Inches	Cm (L x P x H)	Inches (W x D x H)
15	6"	6"	164 x 90 x 74	64 <sup>3</sup> / <sub>4</sub> " x 35 <sup>1</sup> / <sub>2</sub> " x 29 <sup>1</sup> / <sub>4</sub> "
15	6"	6"	186 x 90 x 74	73 <sup>3</sup> / <sub>4</sub> " x 35 <sup>1</sup> / <sub>2</sub> " x 29 <sup>1</sup> / <sub>4</sub> "
15	6"	6"	200 x 100 x 74	78 <sup>3</sup> / <sub>4</sub> " x 39 <sup>1</sup> / <sub>2</sub> " x 29 <sup>1</sup> / <sub>4</sub> "
15	6"	6"	220 x 100 x 74	86 <sup>3</sup> / <sub>4</sub> " x 39 <sup>1</sup> / <sub>2</sub> " x 29 <sup>1</sup> / <sub>4</sub> "
15	6"	6"	240 x 100 x 74	94 <sup>1</sup> / <sub>2</sub> " x 39 <sup>1</sup> / <sub>2</sub> " x 29 <sup>1</sup> / <sub>4</sub> "
19	7 <sup>1</sup> / <sub>2</sub> "	7 <sup>1</sup> / <sub>2</sub> "	260 x 110 x 74	102 <sup>1</sup> / <sub>2</sub> " x 43 <sup>1</sup> / <sub>2</sub> " x 29 <sup>1</sup> / <sub>4</sub> "
19	7 <sup>1</sup> / <sub>2</sub> "	7 <sup>1</sup> / <sub>2</sub> "	280 x 110 x 74	110 <sup>1</sup> / <sub>4</sub> " x 43 <sup>1</sup> / <sub>2</sub> " x 29 <sup>1</sup> / <sub>4</sub> "
19	7 <sup>1</sup> / <sub>2</sub> "	7 <sup>1</sup> / <sub>2</sub> "	300 x 110 x 74	118 <sup>1</sup> / <sub>4</sub> " x 43 <sup>1</sup> / <sub>2</sub> " x 29 <sup>1</sup> / <sub>4</sub> "
19	7 <sup>1</sup> / <sub>2</sub> "	7 <sup>1</sup> / <sub>2</sub> "	320 x 110 x 74	126" x 43 <sup>1</sup> / <sub>2</sub> " x 29 <sup>1</sup> / <sub>4</sub> "
19	7 <sup>1</sup> / <sub>2</sub> "	7 <sup>1</sup> / <sub>2</sub> "	340 x 110 x 74	134" x 43 <sup>1</sup> / <sub>2</sub> " x 29 <sup>1</sup> / <sub>4</sub> "
19	7 <sup>1</sup> / <sub>2</sub> "	7 <sup>1</sup> / <sub>2</sub> "	360 x 110 x 74	141 <sup>3</sup> / <sub>4</sub> " x 43 <sup>1</sup> / <sub>2</sub> " x 29 <sup>1</sup> / <sub>4</sub> "
19	7 <sup>1</sup> / <sub>2</sub> "	7 <sup>1</sup> / <sub>2</sub> "	380 x 110 x 74	149 <sup>3</sup> / <sub>4</sub> " x 43 <sup>1</sup> / <sub>2</sub> " x 29 <sup>1</sup> / <sub>4</sub> "







# Lord

Tavolo con piano in cristallo trasparente 15 mm. A richiesta retroverniciato nei colori del campionario, nella versione brillante o satinata. Struttura in acciaio inox lucido (profilo 40x20x2 mm). Disponibile anche in acciaio inox satinato o in acciaio laccato bianco o nero gofrato. Per le versioni XL da 260x110 cm il piano è sempre in cristallo trasparente 19 mm. Struttura (profilo 50x25x3mm) in acciaio inox lucido o satinato. Su richiesta si realizzano piani con dimensioni speciali.

Table with 15 mm transparent glass top. Painted glass as per samples in the bright or satin version, on request. Structure in bright stainless steel (40x20x2mm). Available also in satin stainless steel or embossed white or black lacquered steel. For the XL versions, from 260x110 cm, the top is always in 19 mm transparent glass. Bright or satin stainless steel structure (50x25x3mm). Customized sizes for the top on request.

Table avec plateau en verre transparent de 15 mms d'épaisseur. Sur demande aussi en verre verni dans les coloris de nos échantillons dans la version brillante ou satinée. Structure en acier inox brillant (40x20x2mm). Disponible aussi en acier inox satiné ou en acier laqué blanc ou noir gaufré. Pour les versions XL, à partir de 260x110 cm, le plateau est toujours transparent de 19 mms d'épaisseur. Structure (50x25x3mm) en acier inox brillant ou satiné. Sur demande il est possible de réaliser plateaux en dimensions spéciales.

Tisch: Glasplatte 15 mm klar. Glas lieferbar auch lackiert nach Musterkarte. Lackierung jeweils hochglanz oder matt satiniert. Gestell Edelstahl (Inox) poliert (Profilmasse 40x20x2mm). Auf Wunsch auch Edelstahl (Inox) gebürstet oder weiss oder schwarz strukturlackiert. Für die XL-Ausführungen, ab 260x110 cm, ist die Glasplatte immer klar 19 mm. Gestell (Profilmasse 50x25x3mm) Edelstahl (Inox) poliert oder gebürstet. Auf Anfrage Glasplatte auch in Sondergrößen lieferbar.

>> Tavolo con piano in cristallo trasparente da 320x110cm e struttura in acciaio inox lucido. Composizione Air Unit da 365x51x91h cm (tre moduli U03 da 120 cm) rivestita in cristallo retroverniciato grigio beige brillante.

Table with transparent glass top 320x110cm and bright stainless steel structure. Air Unit composition 365x51x91h cm (three units U03 of 120 cm) covered by bright taupe painted glass.

Table avec plateau en verre transparent de 320x110 cm et structure en acier inox brillant. Composition Air Unit 365x51x91h cm (trois meubles U03 de 120 cm) recouvert de verre verni taupe brillant.

Tisch mit Glasplatte klar von 320x110cm und Gestell Edelstahl (Inox) poliert. Komposition Air Unit 365x51x91h cm (drei Elementen U03 120 cm) mit beige-grau hochglänzendem Glas umkleidet.

Lord

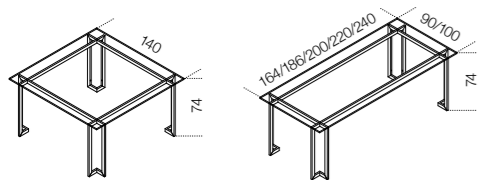

LordXL

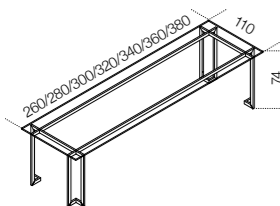

Glass	mm	Inches	Cm (L x P x H)	Inches (W x D x H)
15	6"		140 x 140 x 74	55 1/4" x 55 1/4" x 29 1/4"
15	6"		164 x 90 x 74	64 3/4" x 35 1/2" x 29 1/4"
15	6"		186 x 90 x 74	73 1/4" x 35 1/2" x 29 1/4"
15	6"		200 x 100 x 74	78 3/4" x 39 1/2" x 29 1/4"
15	6"		220 x 100 x 74	86 3/4" x 39 1/2" x 29 1/4"
15	6"		240 x 100 x 74	94 1/2" x 39 1/2" x 29 1/4"
19	7 1/2"		260 x 110 x 74	102 1/2" x 43 1/2" x 29 1/4"
19	7 1/2"		280 x 110 x 74	110 1/4" x 43 1/2" x 29 1/4"
19	7 1/2"		300 x 110 x 74	118 1/4" x 43 1/2" x 29 1/4"
19	7 1/2"		320 x 110 x 74	126" x 43 1/2" x 29 1/4"
19	7 1/2"		340 x 110 x 74	134" x 43 1/2" x 29 1/4"
19	7 1/2"		360 x 110 x 74	141 3/4" x 43 1/2" x 29 1/4"
19	7 1/2"		380 x 110 x 74	149 3/4" x 43 1/2" x 29 1/4"





# Still

Tavolo in cristallo trasparente temperato 15 mm. Parti metalliche in alluminio lucido o alluminio spazzolato a mano nei colori nero o titanio.

Table in 15 mm transparent tempered glass. Bright aluminium or hand brushed aluminium in the colours black or titanium grey metal parts.

Table en verre transparent trempé de 15 mms d'épaisseur. Parties métalliques en aluminium brillant ou aluminium brossé à la main dans les coloris noir ou gris titane.

Tisch: vorgespanntes Glas klar 15 mm. Metallteile Aluminium hochglanz oder Aluminium handgebürstet in den Farben schwarz oder titangrau.

> Tavolo con piano in cristallo trasparente da 260x110 cm e struttura in alluminio lucido.

Table with transparent glass top 260x110 cm and bright aluminium structure.

Table avec plateau en verre transparent de 260x110 cm et structure en aluminium brillant.

Tisch mit Glasplatte klar von 260x110 cm und Gestell Aluminium hochglanz.

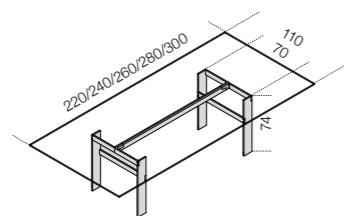

#### Cm (L x P x H)

220 x 110 x 74  
240 x 110 x 74  
260 x 110 x 74  
280 x 110 x 74  
300 x 110 x 74

#### Inches (W x D x H)

86 $\frac{3}{4}$ " x 43 $\frac{1}{2}$ " x 29 $\frac{1}{4}$ "  
94 $\frac{1}{2}$ " x 43 $\frac{1}{2}$ " x 29 $\frac{1}{4}$ "  
102 $\frac{1}{2}$ " x 43 $\frac{1}{2}$ " x 29 $\frac{1}{4}$ "  
110 $\frac{1}{4}$ " x 43 $\frac{1}{2}$ " x 29 $\frac{1}{4}$ "  
118 $\frac{1}{4}$ " x 43 $\frac{1}{2}$ " x 29 $\frac{1}{4}$ "



# Raj

## Raj

Tavolo con piano in cristallo trasparente. Struttura in acciaio inox lucido completa di pannellatura in lastra d'acciaio lucido. Giunto centrale in alluminio cromato.

Table with transparent glass top. Bright stainless steel base with bright steel insert. Chromed aluminium central joint.

Table avec plateau en verre transparent. Piètement en acier inox brillant avec panneau en acier brillant. Joints en aluminium chromé.

Tisch mit Glasplatte klar. Fussgestell Edelstahl (Inox) poliert mit Stahlblechfüllung hochglänzend poliert. Zentralverbindungselement in Aluminium verchromt.

## Raj Light

Tavolo con piano in cristallo trasparente. Struttura in acciaio inox lucido. Giunto centrale in alluminio cromato.

Table with transparent glass top. Bright stainless steel base. Chromed aluminium central joint.

Table avec plateau en verre transparent. Structure en acier inox brillant. Joints en aluminium chromé.

Tisch mit Glasplatte klar. Fussgestell Edelstahl (Inox) poliert. Zentralverbindungselement in Aluminium verchromt.

- > Tavolo con piano in cristallo trasparente da 320x120 cm (a biscotto) e struttura in acciaio inox lucido.
- Table with 320x120 cm (racecourse shape) transparent glass top and bright stainless steel structure.
- Table avec plateau en verre transparent de 320x120 cm (en forme de hippodrome) et piètement en acier inox brillant.
- Tisch mit Klarglasplatte 320x120 cm (Pferderennbahnförmig) und Fussgestell aus Edelstahl (Inox) poliert.

## Raj

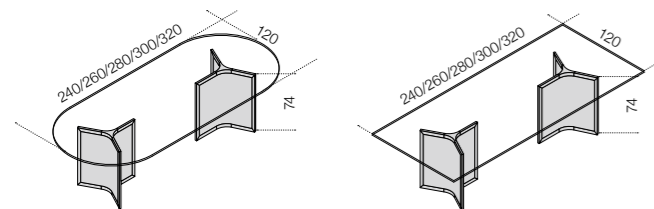

Glass	mm	Inches	Cm (L x P x H)	Inches (W x D x H)
15		6"	240 x 120 x 74	94½" x 47¼" x 29¼"
15		6"	260 x 120 x 74	102½" x 47¼" x 29¼"
19		7½"	280 x 120 x 74	110¼" x 47¼" x 29¼"
19		7½"	300 x 120 x 74	118¼" x 47¼" x 29¼"
19		7½"	320 x 120 x 74	126" x 47¼" x 29¼"

## Raj Light

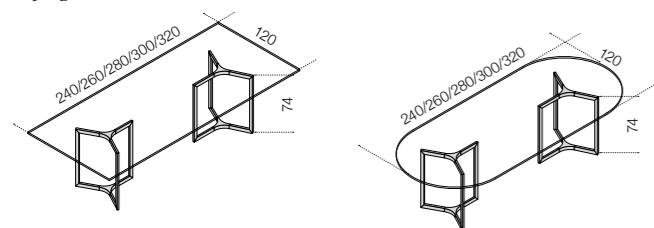

**Raj 4**

Tavolo mono base con giunto centrale in alluminio cromato e piano in cristallo trasparente 15 mm. Struttura in acciaio inox lucido completa di pannellatura in lastra d'acciaio lucido.

Table with one base with chromed aluminium central joint and 15 mm transparent glass top. Bright stainless steel base with bright steel insert.

Table avec une seule piètement avec joint central en aluminium chromé et plateau en verre transparent de 15 mms d'épaisseur. Piètement en acier inox brillant avec panneau en acier brillant.

Tisch mit einem Fussgestell mit Zentralverbindungselement Aluminium verchromt und Glasplatte klar 15 mm. Fussgestell Edelstahl (Inox) poliert mit Stahlblechfüllung hochglänzend lieferbar.

**Raj 4 Light**

Tavolo mono base con giunto centrale in alluminio cromato e piano in cristallo trasparente 15 mm. Struttura in acciaio inox lucido.

Table with one base with chromed aluminium central joint and 15 mm transparent glass top. Bright stainless steel base.

Table avec une seule piètement avec joint central en aluminium chromé et plateau en verre transparent de 15 mms d'épaisseur. Piètement en acier inox brillant.

Tisch mit einem Fussgestell mit Zentralverbindungselement Aluminium verchromt und Glasplatte klar 15mm. Fussgestell Edelstahl (Inox) poliert.

> Tavolo con piano in cristallo trasparente da 210 x130 cm (ovale) e struttura con pannellatura in acciaio inox lucido.

Table with 210x130 cm (oval) transparent glass top and bright stainless steel structure with insert.

Table avec plateau en verre transparent de 210 x130 cm (oval) et piètement avec panneau en acier inox brillant.

Tisch mit Klarglasplatte 210x130 cm (Oval) und Fussgestell mit Stahlblechfüllung aus Edelstahl (Inox) poliert.

Raj 4

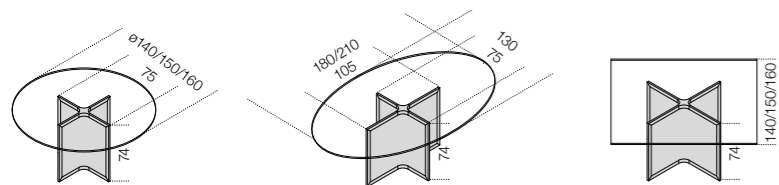

Cm (L x P x H)

ø 140 x 74  
ø 150 x 74  
ø 160 x 74  
180 x 130 x 74  
210 x 130 x 74  
140 x 140 x 74  
150 x 150 x 74  
160 x 160 x 74

Inches (W x D x H)

ø 55 1/4" x 29 1/4"  
ø 59 1/4" x 29 1/4"  
ø 63" x 29 1/4"  
71" x 51 1/4" x 29 1/4"  
82 3/4" x 51 1/4" x 29 1/4"  
55 1/4" x 55 1/4" x 29 1/4"  
59 1/4" x 59 1/4" x 29 1/4"  
63" x 63" x 29 1/4"

Raj 4 Light

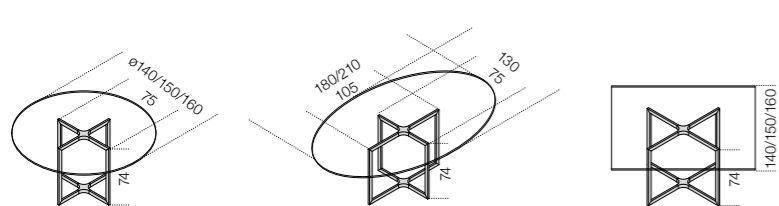

# Eros

Tavolo in cristallo trasparente. Parti metalliche in ottone cromato. Basamento in cristallo temperato 15 mm. Su richiesta si realizzano piani con dimensioni speciali. Per piani di dimensioni superiori a 240 cm sono previste 2 basi.

Table in transparent glass. Chromed brass metal parts. 15 mm tempered glass base. Customized sizes for the top on request. For glass top larger than 240 cm, two bases are recommended.

Table en verre transparent. Parties métalliques en laiton chromé. Piètement en verre trempé de 15 mms d'épaisseur. Sur demande il est possible de réaliser plateaux en dimensions spéciales. Pour des plateaux plus grands de 240 cm il y a 2 piètements.

Tisch aus Klarglas. Metallteile Messing verchromt. Gestell vorge-spanntes Glas 15 mm. Auf Anfrage Glasplatte auch in Sondergrößen lieferbar. Für Glasplatte ab 240 cm ist der Tisch mit zwei Fussgestellen.

> Tavolo con piano in cristallo trasparente da 300 x 120 cm e basi in cristallo trasparente. Parti metalliche in ottone cromato.

Table with 300x120 cm transparent glass top and base. Chromed brass metal parts.

Table avec plateau en verre transparent de 300x120 cm et piètement en verre transparent. Parties métalliques en laiton chromé.

Tisch mit Klarglasplatte 300x120 cm und Klarglasgestell. Metallteile Messing verchromt.

>> Tavolo con piano in cristallo trasparente di ø160 cm e basi in cristallo trasparente. Parti metalliche in ottone cromato.

Table with ø160 cm transparent glass top and base. Chromed brass metal parts.

Table avec plateau en verre transparent de ø160 cm et piètement en verre transparent. Parties métalliques en laiton chromé.

Tisch mit Klarglasplatte ø160 cm und Klarglasgestell. Metallteile Messing verchromt.

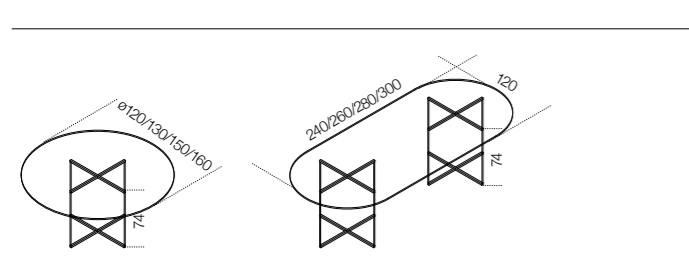

Glass	mm	Inches	Cm (L x P x H)	Inches (W x D x H)
15	6"	6"	ø 120 x 74	ø 47 1/4" x 29 1/4"
15	6"	6"	ø 130 x 74	ø 51 1/4" x 29 1/4"
15	6"	6"	ø 140 x 74	ø 55 1/4" x 29 1/4"
15	6"	6"	ø 150 x 74	ø 59 1/4" x 29 1/4"
15	6"	6"	ø 160 x 74	ø 63" x 29 1/4"
15	6"	6"	240 x 120 x 74	94 1/2" x 47 1/4" x 29 1/4"
19	7 1/2"	7 1/2"	260 x 120 x 74	102 1/2" x 47 1/4" x 29 1/4"
19	7 1/2"	7 1/2"	280 x 120 x 74	110 1/4" x 47 1/4" x 29 1/4"
19	7 1/2"	7 1/2"	300 x 120 x 74	118 1/4" x 47 1/4" x 29 1/4"

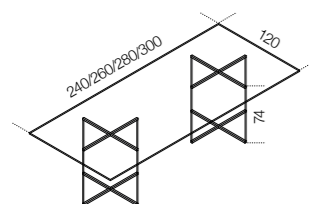





# Upside 14

## Upside 14

Tavolo con piano in cristallo trasparente temperato 15 mm. Basamento in legno laccato nero poro chiuso. Parti metalliche in acciaio inox satinato o ottone satinato. Disco di base in metallo laccato nero.

Table with 15 mm transparent tempered glass top. Base in black lacquered wood closedpore. Metal parts in satin stainless steel or satin brass. Black lacquered metal plate.

Table avec plateau en verre transparent trempé de 15 mms d'épaisseur. Piètement en bois laqué noir pore fermé. Parties métalliques en acier inox satiné ou laiton satiné. Disque en métal laqué noir.

Tisch: Glasplatte vorgespannt klar 15 mm. Gestell Holz schwarz decklackiert. Metallteile Edelstahl (Inox) gebürstet oder Messing satiniert. Metallplatte schwarz lackiert.

> Tavolo con piano in cristallo trasparente extralight da ø130 cm. Basamento in legno laccato nero poro chiuso. Parti metalliche in ottone satinato. Disco di base in metallo laccato nero.

Table with extralight transparent glass top ø130 cm. Base in black closed pore lacquered wood. Metal parts in satin brass. Black lacquered metal plate.

Table avec plateau en verre transparent extralight de ø130 cm. Piètement en bois laqué noir pore fermé. Parties métalliques en laiton satiné. Disque en métal laqué noir.

Tisch mit Glasplatte klar Extralight von ø130 cm. Gestell Holz schwarz decklackiert. Metallteile Messing satiniert. Metallplatte schwarz lackiert.

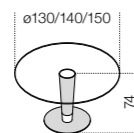

### Cm (L x P x H)

ø 130 x 74  
ø 140 x 74  
ø 150 x 74

### Inches (W x D x H)

ø 51¼" x 29¼"  
ø 55¼" x 29¼"  
ø 59¼" x 29¼"



# Upside/RaFx

## Upside

Tavolo con piano in cristallo trasparente temperato 15 mm. Basamento in rovere sbiancato, tinto wengé o tinto tabacco. Disponibile anche laccato bianco, grigio umbro, nero poro chiuso o effetto tessuto nei colori castagna, sabbia e canapa. Parti metalliche in acciaio inox satinato.

Table with 15 mm transparent tempered glass top. Base in whitened oak, wengé stained or tobacco stained. Available also in white, dark grey, black closed pore or chestnut, sand and canapa with "fabric" touch effect lacquered. Metal parts in satin stainless steel.

Table avec plateau en verre transparent trempé de 15 mms d'épaisseur. Piètement en chêne blanchi, teinté wengé ou teinté tabac. Disponible aussi laqué blanc, gris foncé, noir pore fermé ou en effet tissu dans les coloris châtaigne, sablé et chanvre. Parties métalliques en acier inox satiné.

Tisch: Glasplatte vorgespannt klar 15 mm. Gestell Eiche gebleicht, Wengé gebeizt oder Tabakfarbe gebeizt. Lieferbar auch in weiss, dunkelgrau, schwarz decklackiert oder lackiert mit Stoff-Effekt in kastanienbraun, sandfarben und hanffarben. Metallteile nur Edelstahl (Inox) gebürstet.

## Rafx

Tavolo con piano in cristallo trasparente o "grigio Italia" temperato 12 mm. Basamento in rovere sbiancato, tinto wengé o tinto tabacco. Disponibile anche laccato bianco, grigio umbro, nero poro chiuso o effetto tessuto nei colori castagna, sabbia e canapa. Parti metalliche in acciaio inox satinato.

Table with 12 mm transparent or smoked "grigio Italia" tempered glass top. Base in whitened oak, wengé stained or tobacco stained. Available also in white, dark grey, black closed pore or chestnut, sand and canapa with "fabric" touch effect lacquered. Metal parts in satin stainless steel.

Table avec plateau en verre transparent ou "grigio Italia" fumé trempé de 12 mms d'épaisseur. Piètement en chêne blanchi, teinté wengé ou teinté tabac. Disponible aussi laqué blanc, gris foncé, noir pore fermé ou en effet tissu dans les coloris châtaigne, sablé et chanvre. Parties métalliques en acier inox satiné.

Tisch: Glasplatte vorgespannt klar oder Rauchglas "grigio Italia" 12 mm. Gestell Eiche gebleicht, Wengé gebeizt oder Tabakfarbe gebeizt. Lieferbar auch in weiss, dunkelgrau, schwarz decklackiert oder lackiert mit Stoff-Effekt in kastanienbraun, sandfarben und hanffarben. Metallteile nur Edelstahl (Inox) gebürstet.

Upside: Tavolo con piano in cristallo trasparente da ø150 cm. Basamento in rovere tinto wengé. Parti metalliche in acciaio inox satinato.

Upside: Table with transparent glass top ø150 cm. Base in wengé stained oak. Metal parts in satin stainless steel.

Upside: Table avec plateau en verre transparent de ø150 cm. Piètement en chêne teinté wengé. Parties métalliques en acier inox satiné.

Upside: Tisch mit Klarglasplatte von ø150 cm. Gestell Eiche Wengé gebeizt. Metallteile Edelstahl (Inox) gebürstet.

Rafx: Tavolo con piano in cristallo trasparente di ø100 cm e base in legno laccato bianco a poro chiuso.

Rafx: Table with ø100 cm transparent glass top and white closed pore lacquered base.

Rafx: Table avec plateau en verre transparent de ø100 cm et piètement en bois laqué blanc pore fermé.

Rafx: Tisch mit Klarglasplatte ø100 cm und Holzgestell weiss decklackiert.



Upside

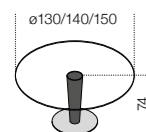

Rafx

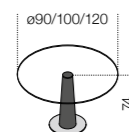

Upside

Rafx

### Cm (L x P x H)

ø 130 x 74  
ø 140 x 74  
ø 150 x 74  
ø 90 x 74  
ø 100 x 74  
ø 120 x 74

### Inches (W x D x H)

ø 51¼" x 29¼"  
ø 55¼" x 29¼"  
ø 59¼" x 29¼"  
ø 35½" x 29¼"  
ø 39½" x 29¼"  
ø 47¼" x 29¼"



# Big Basic

Tavolo con piano in cristallo trasparente o "grigio Italia" temperato 12 mm. A richiesta retroverniciato nei colori del campionario nella versione brillante o satinata. Struttura in acciaio inox satinato o laccato effetto tessuto nei colori castagna, sabbia e canapa. Disco di base in acciaio inox satinato.

Table with 12 mm transparent or smoked "grigio Italia" tempered glass top. Painted glass as per samples in the bright or satin version, on request. Metal parts in satin stainless steel or lacquered with "fabric" touch effect in the colours chestnut, sand and canapa. Satin stainless steel metal plate base.

Table avec plateau en verre transparent ou "grigio Italia" fumé trempé de 12 mms d'épaisseur. Sur demande aussi en verre verni dans les coloris de nos échantillons dans la version brillante ou satinée. Parties métalliques en acier inox satiné ou laqué avec effet tissu dans les coloris châtaigne, sablé et chanvre. Disque en acier inox satiné.

Tisch: Glasplatte vorgespannt klar oder Rauchglas "grigio Italia" 12 mm. Glas lieferbar auch lackiert nach Musterkarte. Lackierung jeweils hochglanz oder matt satiniert. Metallteile Edelstahl (Inox) gebürstet oder lackiert mit Stoff-Effekt in kastanienbraun, sandfarben und hanffarben. Metallplatte Edelstahl (Inox) gebürstet.

> Tavolo con piano in cristallo trasparente di ø120 cm e struttura laccata canapa effetto tessuto.

Table with ø120 cm transparent glass top and canapa with "fabric" touch effect lacquered structure.

Table avec plateau en verre transparent de ø120 cm et piètement laqué chanvre en effet tissu.

Tisch mit Klarglasplatte ø120 cm und Fussgestell hanffarben mit Stoff-Effekt lackiert.

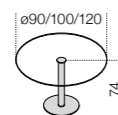

#### Cm (L x P x H)

ø 90 x 74  
ø 100 x 74  
ø 120 x 74

#### Inches (W x D x H)

ø 35½" x 29¼"  
ø 39½" x 29¼"  
ø 47¼" x 29¼"



# Smart

Tavolo con struttura in acciaio inox lucido. Su richiesta anche in acciaio inox satinato. Piano in cristallo 12 mm temperato retroverniciato nei colori del campionario nella versione brillante o satinata e telaio in acciaio inox.

Table with bright stainless steel structure. Available also satin stainless steel. 12 mm tempered painted glass top as per samples, in the bright or satin version. Stainless steel top frame.

Table avec structure en acier inox brillant. Sur demande aussi en acier inox satiné. Plateau en verre de 12 mms d'épaisseur verni dans les coloris de nos échantillons dans la version brillante ou satiné. Cadre du plateau en acier inox.

Tisch: Gestell Edelstahl (Inox) poliert. Auf Wunsch auch Edelstahl (Inox) gebürstet. Glasplatte 12 mm vorgespannt lackiert nach Musterkarte. Lackierung jeweils hochglanz oder matt satiniert. Bodenrahmen Edelstahl (Inox).

v Tavolo con piano in cristallo retroverniciato grigio umbro satinato da 300x110 cm e struttura in acciaio inox satinato.

Table with 300x110 cm satin dark grey painted glass top and satin stainless steel structure.

Table avec plateau en verre verni gris foncé satiné de 300x110 cm et structure en acier inox satiné.

Tisch mit Glasplatte dunkelgrau matt satiniert 300x110 cm und Gestell aus Edelstahl (Inox) gebürstet.

Smart

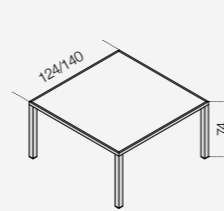

XL

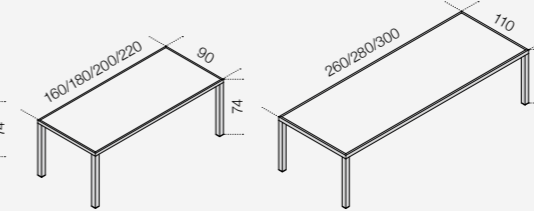

## Cm (L x P x H)

124 x 124 x 74  
140 x 140 x 74  
160 x 90 x 74  
180 x 90 x 74  
200 x 90 x 74  
220 x 90 x 74  
260 x 110 x 75  
280 x 110 x 75  
300 x 110 x 75

## Inches (W x D x H)

49" x 49" x 29¼"  
55¼" x 55¼" x 29¼"  
63" x 35½" x 29¼"  
71" x 35½" x 29¼"  
78¾" x 35½" x 29¼"  
86¾" x 35½" x 29¼"  
102½" x 43½" x 29¾" XL  
110¼" x 43½" x 29¾"  
118¼" x 43½" x 29¾"

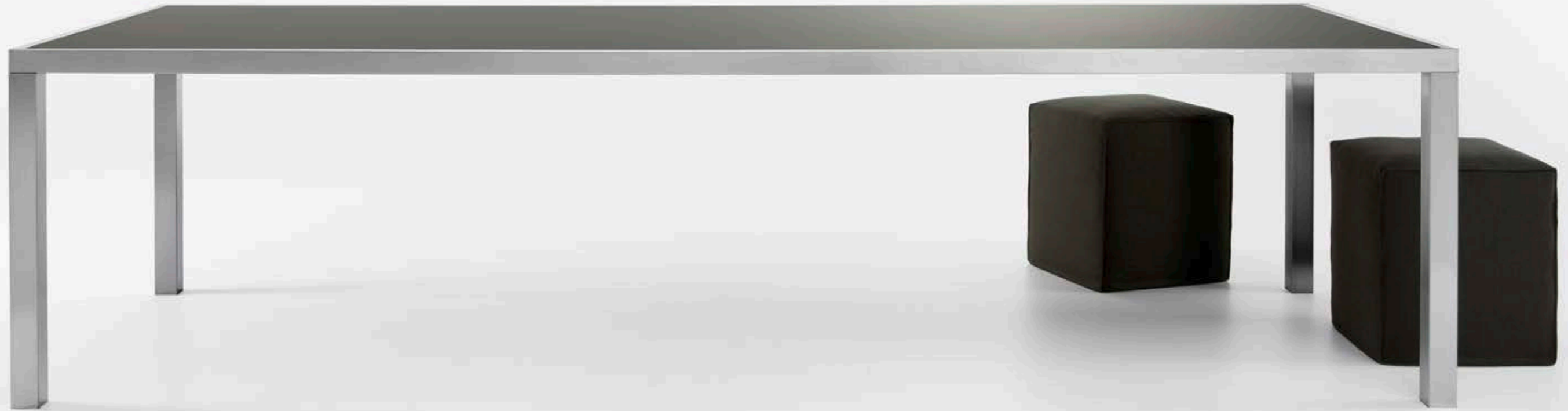

# Yan

Tavolo con piano in cristallo trasparente. Basi in legno rivestite in cristallo retroverniciato nei colori del campionario nella versione brillante o satinata. Disponibile anche in cristallo specchiato naturale o "grigio Italia" oppure in legno laccato bianco, nero o grigio umbro.

Table with transparent glass top. Wooden base covered by painted glass as per samples in the bright or satin version. Available also mirrored or smoked "grigio Italia" mirrored glass or white, black or dark grey lacquered wood.

Table avec plateau en verre transparent. Piètement en bois recouvert de verre verni dans les coloris de nos échantillons dans la version brillante ou satinée. Disponible aussi en verre miroité ou miroir "grigio Italia" fumé ou en bois laqué blanc, noir ou gris foncé.

Tisch: Glasplatte klar. Gestell Holz mit lackiertem Glas nach Musterkarte umkleidet. Lackierung jeweils hochglanz oder matt satiniert. Auf Wunsch auch verspiegelt oder Spiegel-Rauchglas "grigio Italia" oder Holz weiss, schwarz oder dunkelgrau lackiert.

√ Tavolo con piano in cristallo trasparente da 300x120 cm e basi rivestite in specchio "grigio Italia".

Table with 300x120 cm transparent glass top and wooden base covered with smoked "grigio Italia" mirrored glass.

Table avec plateau en verre transparent de 300x120 cm et piètement en bois recouvert de miroir "grigio Italia".

Tisch mit Klarglasplatte 300x120 cm und Holzgestell mit Spiegel-Rauchglas "grigio Italia" umkleidet.

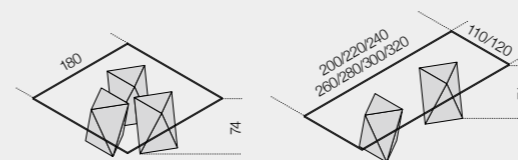

Cm (L x P x H)

180 x 180 x 74  
200 x 110 x 74  
220 x 110 x 74  
240 x 110 x 74  
260 x 120 x 74  
280 x 120 x 74  
300 x 120 x 74  
320 x 120 x 74

Inches (W x D x H)

71" x 71" x 29¼"  
78¾" x 43½" x 29¼"  
86¾" x 43½" x 29¼"  
94½" x 43½" x 29¼"  
102½" x 47¼" x 29¼"  
110¼" x 47¼" x 29¼"  
118¼" x 47¼" x 29¼"  
126" x 47¼" x 29¼"



# Ever

Tavolo in cristallo trasparente extralight 15 mm. Parti metalliche in alluminio cromato.

Table in 15 mm extralight transparent glass. Chromed aluminium metal parts.

Table en verre extralight de 15 mms d'épaisseur. Parties métalliques en aluminium brillant.

Tisch: Glasklar Extralight 15 mm. Metallteile Aluminium verchromt.

v Tavolo con piano in cristallo trasparente extralight da 280x100 cm. Parti metalliche in alluminio lucido.

Table with 280x100 cm extralight transparent glass top. Bright aluminium metal parts.

Table avec plateau en verre transparent extralight de 280x100 cm. Parties métalliques en aluminium brillant.

Tisch mit Glasplatte klar Extralight 280x100 cm. Metallteile Aluminium hochglanz.

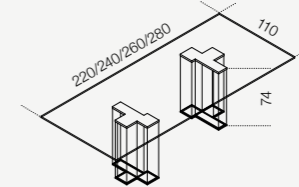
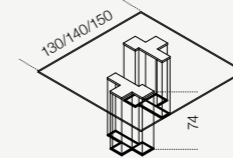
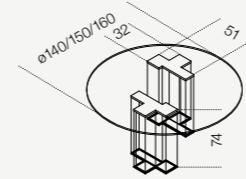

## Cm (L x P x H)

ø 140 x 74  
ø 150 x 74  
ø 160 x 74  
130 x 130 x 74  
140 x 140 x 74  
150 x 150 x 74  
220 x 110 x 74  
240 x 110 x 74  
260 x 110 x 74  
280 x 110 x 74

## Inches (W x D x H)

ø 55¼" x 29¼"  
ø 59¼" x 29¼"  
ø 63" x 29¼"  
51¼" x 51¼" x 29¼"  
55¼" x 55¼" x 29¼"  
59¼" x 59¼" x 29¼"  
86¼" x 43½" x 29¼"  
94½" x 43½" x 29¼"  
102½" x 43½" x 29¼"  
110¼" x 43½" x 29¼"

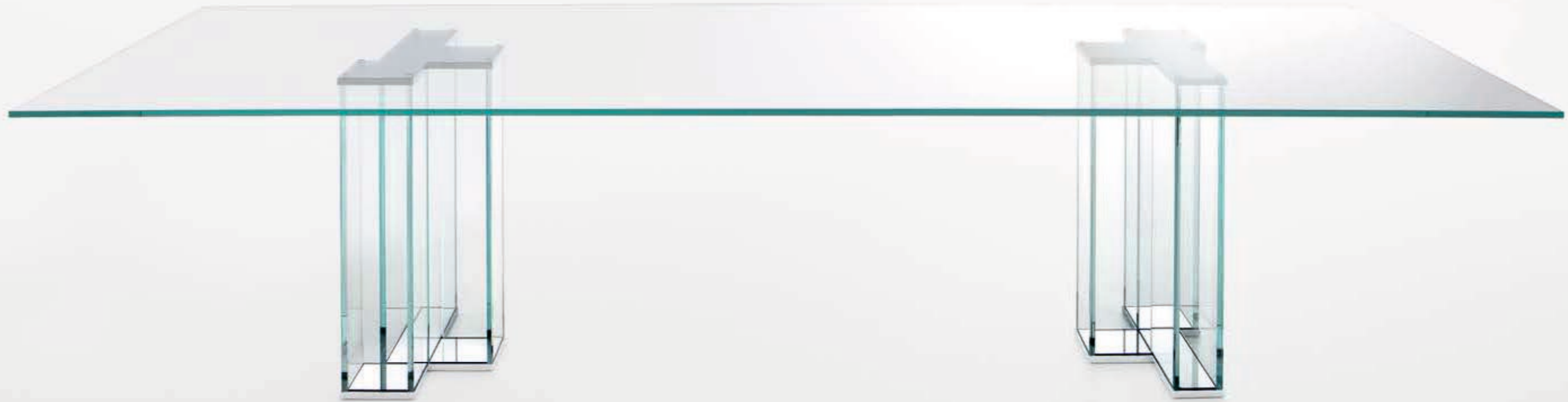

# Adam

Tavolo in cristallo trasparente. Basamenti in cristallo 15 mm, curvati a fuoco e molati a mano. Parti metalliche in ottone cromato. Disponibile anche senza parti metalliche (altezza finita: 72 cm). Su richiesta si realizzano piani con dimensioni speciali. Per piani di dimensioni superiori a 260 cm sono previste 4 basi.

Table in transparent glass. Bases in 15 mm thick glass curved by fire and hand bevelled. Chromed brass clips. Available also without metal parts (total height: 72 cm). Customized sizes for the top on request. For glass top larger than 260 cm, four bases are recommended.

Table en verre transparent. Piètements en verre de 15 mms d'épaisseur courbé au feu et meulé à la main. Parties métalliques en laiton chromé. Disponible aussi sans parties métalliques (hauteur totale: 72 cm). Sur demande il est possible de réaliser plateaux en dimensions spéciales. Pour des plateaux plus grands de 260 cm il y a 4 piètements.

Tisch aus Klarglas. Gestell Glas 15 mm feuergebogen und handpoliert. Metallteile Messing verchromt. Auf Wunsch ohne Metallteile (Gesamthöhe: 72cm). Auf Anfrage Glasplatte auch in Sondergrößen lieferbar. Für Glasplatte ab 260 cm ist der Tisch mit vier Fussgestellen.

> Tavolo con piano in cristallo trasparente da 240 x120 cm (a biscotto). Basi in cristallo trasparente con parti metalliche in ottone cromato.

Table with 240x120 cm (racecourse shape) transparent glass top. Transparent bases with chromed metal parts.

Table avec plateau en verre transparent de 240x120 cm (en forme de hippodrome). Piètement en verre transparent avec parties métalliques en laiton chromé.

Tisch mit Klarglasplatte 240 x120 cm (Pferdrennbahnförmig). Gestell aus Klarglas mit Metallteile Messing verchromt.

	Glass	mm	Inches	Cm (L x P x H)		Inches (W x D x H)
	15	6"		ø 130 x 74	○	ø 51¼" x 29¼"
	15	6"		ø 150 x 74	○	ø 59¼" x 29¼"
	15	6"		160 x 130 x 74	○	63" x 51¼" x 29¼"
	15	6"		180 x 130 x 74	○	71" x 51¼" x 29¼"
	15	6"		210 x 130 x 74	○	82¾" x 51¼" x 29¼"
	15	6"		210 x 120 x 74	○	82¾" x 47¼" x 29¼"
	15	6"		240 x 120 x 74	○	94½" x 47¼" x 29¼"
	15	6"		260 x 120 x 74	○	102½" x 47¼" x 29¼"
	19	7½"		280 x 120 x 74	○	110¼" x 47¼" x 29¼"
	19	7½"		300 x 120 x 74	○	118¼" x 47¼" x 29¼"



# Supercalif...

Tavolo in cristallo con piano trasparente 15 mm molato a bisello. Basamento a doghe di cristallo specchiato.

Table with 15 mm transparent bevelled glass top. Base made of mirrored glass staves.

Table en verre avec plateau transparent biseauté de 15 mms d'épaisseur. Piètement en lamelles de verre miroité.

Tisch: Glasplatte klar 15 mm mit Facettschliff. Gestell verspiegelte, gestufte Glasstäbe.

> Tavolo con piano in cristallo trasparente extralight da 280x100 cm. Basamento in cristallo extralight specchiato.

Table with 280x100 cm extralight transparent glass top. Extralight mirrored glass base.

Table en verre transparent extralight de 280 x100 cm. Piètement en verre extralight miroité.

Tisch mit Glasplatte klar Extralight 280x100 cm. Gestell aus verspiegeltem Extralight Glas.

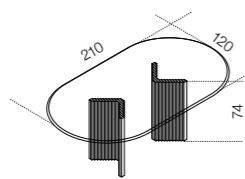
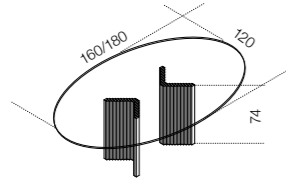
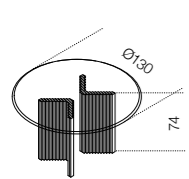

## Cm (L x P x H)

ø 130 x 74  
160 x 130 x 74  
180 x 130 x 74  
210 x 120 x 74  
130 x 130 x 74  
186 x 96 x 74  
210 x 96 x 74  
240 x 100 x 74  
260 x 100 x 74  
280 x 100 x 74

## Inches (W x D x H)

ø 51¼" x 29¼"  
63" x 51¼" x 29¼"  
71" x 51¼" x 29¼"  
82¾" x 47¼" x 29¼"  
51¼" x 51¼" x 29¼"  
73¼" x 38" x 29¼"  
82¾" x 38" x 29¼"  
94½" x 39½" x 29¼"  
102½" x 39½" x 29¼"  
110¼" x 39½" x 29¼"

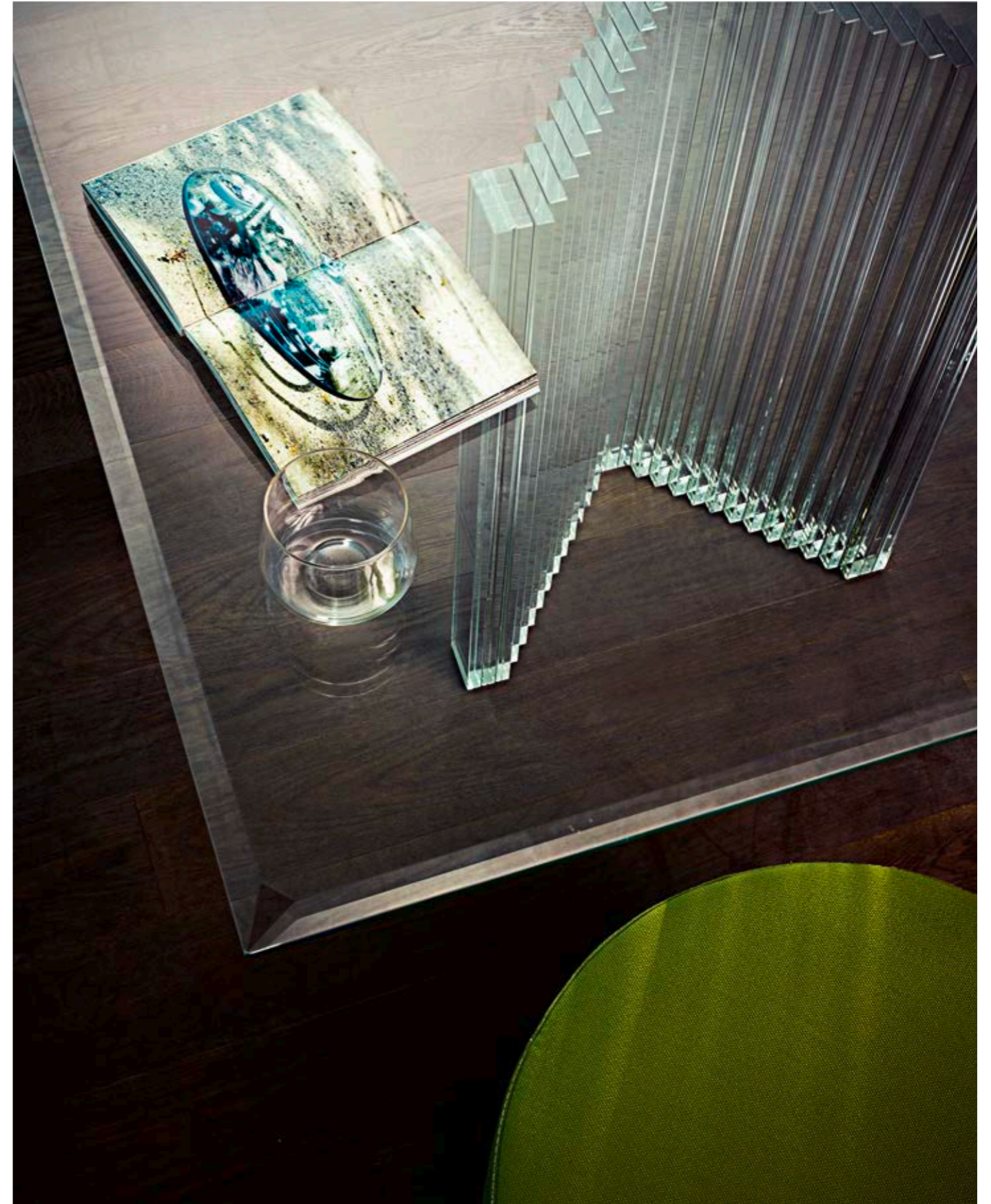
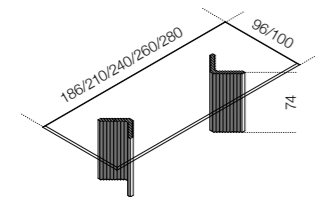
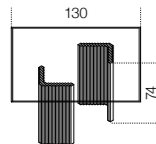





**Accessori ufficio/  
Office Accessories/  
Accessoires  
pour le bureau/  
Accessoires für Büro**

226 Cover Cable Plate 1, 2, 3  
228 Cable Tube  
230 Glass Pad  
230 Mouse Pad  
228 Movie Tower  
230 Sottomano  
228 Snake

**Cover cable plate 1**

Passacavi in alluminio brill. Su richiesta può essere verniciato nella stessa tonalità del cristallo.

Bright aluminium cable management. Painted in the same colour of the glass top, on request.

Cache fils en aluminium brillant. Sur demande disponible verni dans les mêmes coloris du plateau en verre.

Kabeldurchlass aus Aluminium hochglänzend poliert. Auf Wunsch lackiert in der gleichen Farbe der Glasplatte.

Cm (L x P)  
8 x 21

Inches (W x D)  
3¼" x 8½"

**Cover cable plate 2**

Passacavi in alluminio brill.

Bright aluminium cable management.

Cache fils en aluminium brillant.

Kabeldurchlass aus Aluminium hochglänzend poliert.

Cm (L x P)  
8 x 21

Inches (W x D)  
3¼" x 8½"

**Cover cable plate 3**

Passacavi in alluminio brill. Su richiesta può essere verniciato nella stessa tonalità del cristallo.

Bright aluminium cable management. Painted in the same colour of the glass top, on request.

Cache fils en aluminium brillant. Sur demande disponible verni dans les mêmes coloris du plateau en verre.

Kabeldurchlass aus Aluminium hochglänzend poliert. Auf Wunsch lackiert in der gleichen Farbe der Glasplatte.

Cm (L x P)  
8 x 8

Inches (W x D)  
3¼" x 3¼"

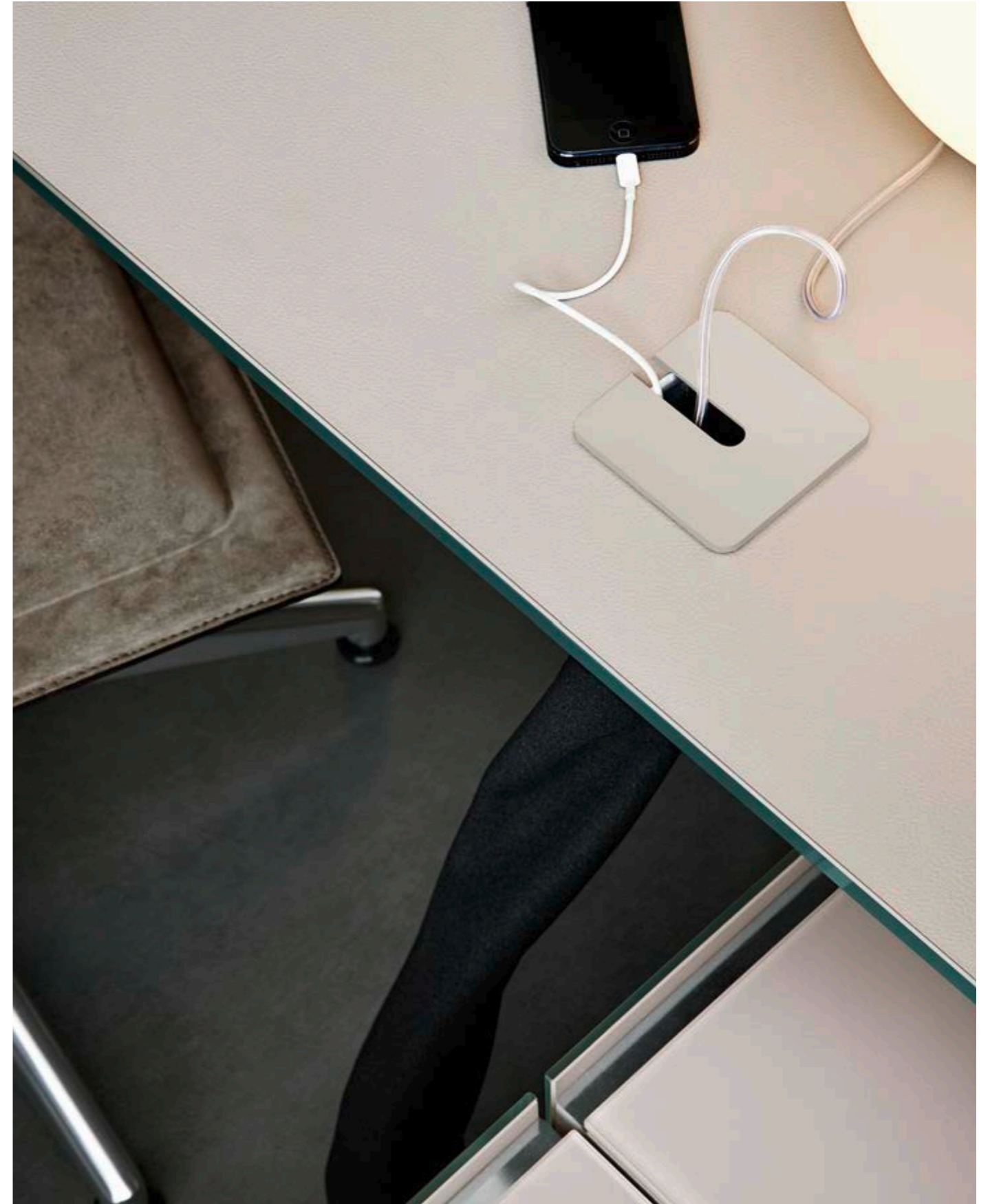

**Movie Tower**

Mobile per computer in cristallo trasparente temperato 8 mm. Parti metalliche in acciaio inox lucido. A richiesta acciaio inox satinato, ottone protetto o laccato bianco o nero goffrato. Ruote con freno.

Module for computer in 8 mm transparent tempered glass. Bright stainless steel metal parts. Satin stainless steel, protected brass or embossed white or black lacquered metal parts, on request. Castors with brake.

Meuble ordinateur en verre transparent trempé de 8 mm d'épaisseur. Parties métalliques en acier inox brillant. Sur demande acier inox satiné, laiton protégé ou laqué, blanc ou noir gaufré. Roulettes avec frein.

Computermöbel: vorge-spanntes Glas klar 8 mm. Metallteile Edelstahl (Inox) poliert. Auf Wunsch Edelstahl (Inox) gebürstet, Messing zaponiert oder weiss oder schwarz structurallaciert. Feststellbare Rollen.

Cm (L x P x H)  
30 x 40 x 67

Inches (W x D x H)  
12" x 15¾" x 26½"

**Snake**

Portacavi in plastica trasparente. Si applica all'interno del foro oppure sul bordo del piano.

Transparent plastic cable management. To be fixed to the hole or to the edge of the top.

Porte câbles en plastique transparent. Se positionne à l'intérieur du trou ou au bord du plateau.

Der Kabelanal aus transparentem Kunststoff wird in der Bohrung oder an der Platte befestigt.

Cm (L x P x H)  
ø 6 x 83

Inches (W x D x H)  
ø 2½" x 32¾"

**Cable tube**

Portacavi in 3D Tex darc, da applicare al foro delle scrivanie. Anello superiore in acciaio satinato.

3D Tex darc cable management to be fixed to the hole of the desks. Satin steel upper ring.

Porte câbles en 3D Tex darc à fixer au trou de bureaux. Bague supérieur en acier satiné.

Der Kabelanal aus 3D Tex-Stoff darc wird in der Bohrung von Schreibtischen befestigt. Oberer Ring aus Stahl satiniert.



**Glass Pad**

Sottomano in cristallo temperato retroverniciato satinato nei colori del campionario.

Tempered satin painted glass writing pad as per samples.

Sous-main en verre trempé verni satiné dans les coloris de nos échantillons.

Schreibunterlage aus Glas vorgespannt matt satiniert nach Mustercarte lacciert.

	Cm (L x P x H)		Inches (W x D x H)	
	70 x 38 x 0,6		27 3/4" x 15" x 1/4"	
President Junior	65 x 41 x 0,6		25 3/4" x 16 1/4" x 1/4"	
President Senior	75 x 43 x 0,6		29 3/4" x 17" x 1/4"	

**Sottomano**

Sottomano in cuoio o pelle scamosciata. Disponibile nei colori del campionario.

Leather writing pad or suede writing pad. Available in the finishes as per samples.

Sous-main en cuir ou suédine. Disponible dans les coloris de nos échantillons.

Schreibtischunterlage aus Leder oder Wildleder. Lieferbar in den Farben nach Mustercarte.

	Cm (L x P)		Inches (W x D)	
Elegance	81 x 35		31 3/4" x 13 3/4"	
President Junior	65 x 43		25 3/4" x 17"	
President Senior	75 x 45		29 3/4" x 17 3/4"	

**Mouse Pad**

Mouse pad in cristallo temperato retroverniciato satinato nei colori del campionario.

Satin painted glass mouse pad as per samples.

Mouse pad en verre trempé verni satiné dans les coloris de nos échantillons.

Mouse pad aus Glas matt satiniert nach Mustercarte lacciert.

> Mouse pad in cristallo temperato retroverniciato grigio beige.

Mouse pad in taupe powder tempered painted glass.

Mouse pad en verre trempé verni taupe satiné.

Mouse pad aus Glas vorgespannt Beigegrau matt satiniert.

Cm (L x P)	Inches (W x D)
23 x 23	9 1/4" x 9 1/4"



# **Finiture/ Finishes/ Finitions/ Ausführungen**

238 Ecoleather  
239 Fabrics  
238 FeltWGS  
234 Glass  
235 Glass Pandora  
238 Leather / Leather Sottomano  
236 Metal  
238 Suede  
238 Velvet  
237 Wood  
237 WoodLayer

Cristalli  
Glass  
Verre  
Glas

				
Trasparente Transparent Transparent Klar	Extralight	"Grigio Italia" Smoked "grigio Italia" "Grigio Italia" fumé Rauchglas "grigio Italia"	Specchio Mirror Miroir Spiegel	Specchio "grigio Italia" "Grigio Italia" smoked mirror Miroir "grigio Italia" fumé Spiegel-Rauchglas "grigio Italia"
				
Stopsol bronzo Bronze stopsol Stopsol bronze Stopsol bronzefarben	Serigrafato grigio specchiato Grey screen-printed mirrored Gris sérigraphié miroité Verspiegelt und serigraphiert grau	Bianco brillante Bright white Blanc brillant Weiss hochglänzend	Bianco satinato Satin white Blanc satiné Weiss matt satiniert	Panna brillante Bright off-white Crème brillant Cremfarben hochglänzend
				
Panna satinato Satin off white Crème satiné Cremfarben matt satiniert	Sabbia brillante Bright sand Sablé brillant Sandfarben hochglänzend	Nero brillante Bright black Noir brillant Schwarz hochglänzend	Nero satinato Satin black Noir satiné Schwarz matt satiniert	Cemento brillante Bright cement Ciment brillant Zement hochglänzend
				
Cemento satinato Satin cement Ciment satiné Zement matt satiniert	Champagne brillante Bright champagne Champagne brillant Champagne hochglänzend	Champagne satinato Satin champagne Champagne satiné Champagne matt satiniert	Visone brillante Bright mink Vison brillant Nerzfarbe hochglänzend	Visone satinato Satin mink Vison satiné Nerzfarbe matt satiniert
				
Cipria brillante Bright rose powder Poudre brillant Puderfarben hochglänzend	Cipria satinato Satin rose powder Poudre satiné Puderfarben matt satiniert	Cadet blue brillante Bright cadet blue Cadet bleu brillant Kadettenblau hochglänzend	Cadet blue satinato Satin cadet blue Cadet bleu satiné Kadettenblau matt satiniert	Castagna brillante Bright chestnut Châtaigne brillant Kastanienbraun hochglänzend
				
Castagna satinato Satin chestnut Châtaigne satiné Kastanienbraun matt satiniert	Oliva brillante Bright olive Vert olive brillant Olivenfarben hochglänzend	Oliva satinato Satin olive Vert olive satiné Olivenfarben matt satiniert	Grigio beige brillante Bright taupe Taupe brillant Beige grau hochglänzend	Grigio beige satinato Satin taupe Taupe satiné Beige grau matt satiniert
				
Grigio umbro brillante Bright dark grey Gris foncé brillant Dunkelgrau hochglänzend	Grigio umbro satinato Satin dark grey Gris foncé satiné Dunkelgrau matt satiniert	Blu grigio brillante Bright blue-grey Blue gris brillant Blau grau hochglänzend	Blu grigio satinato Satin blue-grey Blue gris satiné Blau grau matt satiniert	Liquirizia brillante Bright liquorice black Régliasse brillant Schwarzbraun hochglänzend
				
Liquirizia satinato Satin liquorice black Régliasse satiné Schwarzbraun matt satiniert	Grigio umbro metallizzato Dark grey metallic Gris foncé métallisé Dunkelgrau metallic			

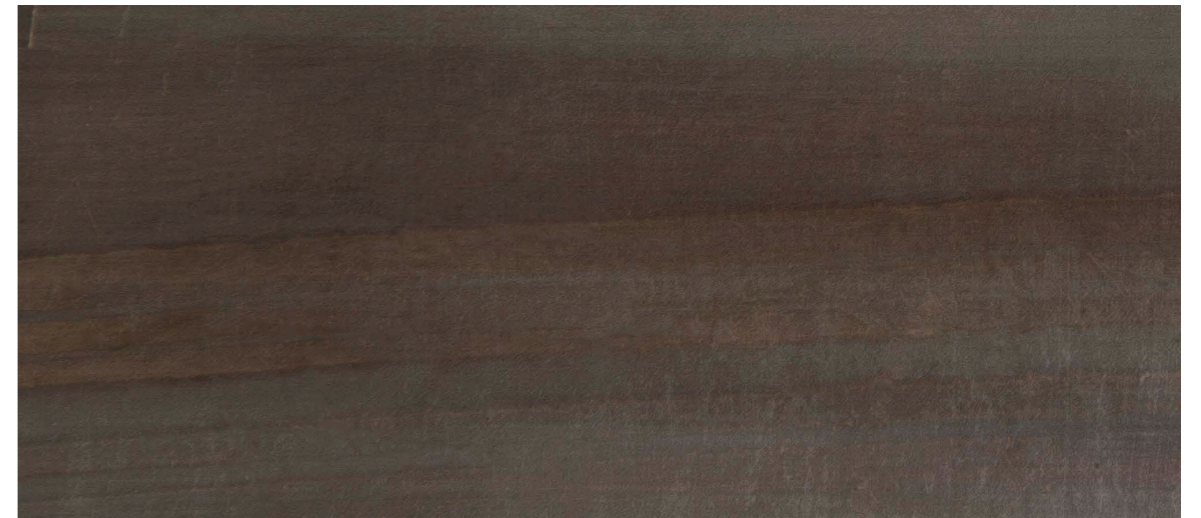
Cristalli Pandora  
Glass Pandora  
Verre Pandora  
Glas PandoraInterno  
Inside  
Interieur  
InnenEsterno  
Outside  
Exterieur  
Aussen

## Finishes

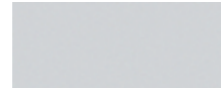
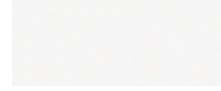
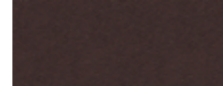
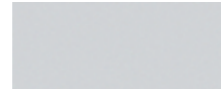
Metalli  
Metal  
Métal  
MetallteileAcciaio inox lucido  
Bright stainless steel  
Acier inox brillant  
Edelstahl (Inox) poliertAcciaio inox satinato  
Satin stainless steel  
Acier inox satiné  
Edelstahl (Inox) gebürstetAlluminio anodizzato  
Anodised aluminium  
Aluminium anodisé  
Aluminium eloxiertCromo  
Chrome  
Chrome  
ChromOttone  
Brass  
Laiton  
MessingOttone satinato  
Satin brass  
Laiton satiné  
Messing satiniertOttone brunito a mano  
Hand burnished brass  
Laiton bruni à la main  
Messing handbruniertBianco gofrato  
Embossed white  
Blanc gaufré  
Weiss strukturlackiertNero gofrato  
Embossed black  
Noir gaufré  
Schwarz strukturlackiertMoro gofrato  
Embossed dark brown  
Marron foncé gaufré  
Dunkel braun strukturlackiertBrunito  
Burnished  
Bruni  
BruniertGrigio chiaro metallizzato  
Light grey metallic  
Gris clair métallisé  
Hellgrau metallicLaccato alluminio  
Lacquered aluminium  
Aluminium laqué  
Aluminium lackiertCanapa effetto tessuto  
Canapa fabric touch effect  
Chanvre effet tissu  
Hanffarben Stoff-EffektSabbia effetto tessuto  
Sand fabric touch effect  
Sablé effet tissu  
Sandfarben Stoff-EffektCastagna effetto tessuto  
Chestnut fabric touch effect  
Châtaigne effet tissu  
Kastanienbraun Stoff-EffektAlluminio spazzolato nero  
Black brushed aluminium  
Aluminium brossé noir  
Aluminium schwarz gebürstetAlluminio spazzolato titanio  
Titanium grey brushed  
aluminium  
Aluminium brossé gris titane  
Aluminium titangrau  
gebürstetAlluminio spazzolato oro  
Gold brushed aluminium  
Aluminium brossé or  
Aluminium goldfarben  
gebürstetBronzo patinato  
Patinated bronze  
Bronze patiné  
Bronzefarben patiniertSpazzolato moro  
Dark brown brushed  
Marron brossé  
Dunkel braun gebürstet

## Finishes

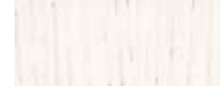
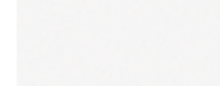
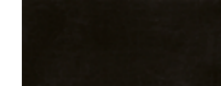
Legni  
Wood  
Bois  
HolzFrassino naturale  
Natural ash  
Frêne naturel  
Eschenholz natureRovere spazzolato  
Brushed natural oak  
Chêne naturel brossé  
Eiche natur gebürstetRovere sbiancato  
Whitened oak  
Chêne blanchi  
Eiche gebleichtRovere tinto wengé  
Wengé stained oak  
Chêne teinté wengé  
Eiche wengé gebeiztTinto tabacco  
Tobacco stained  
Teinté tabac  
Tabakfarbe gebezeitBianco poro aperto  
White open pore  
Blanc pores ouverts  
Weiss offenporigBianco poro chiuso  
White closed pore  
Blanc pores clos  
Weiss decklackiertNero poro aperto  
Black open pore  
Noir pores ouverts  
Schwarz offenporigNero poro chiuso  
Black closed pore  
Noir pores clos  
Schwarz decklackiertGrigio umbro poro chiuso  
Dark grey closed pore  
Gris foncé pores clos  
Dunkel grau decklackiertCanapa effetto tessuto  
Canapa fabric touch effect  
Chanvre effet tissu  
Hanffarben Stoff-EffektSabbia effetto tessuto  
Sand fabric touch effect  
Sablé effet tissu  
Sandfarben Stoff-EffektCastagna effetto tessuto  
Chestnut fabric touch effect  
Châtaigne effet tissu  
Kastanienbraun Stoff-EffektLegni Layer  
Wood Layer  
Bois Layer  
Holz LayerZafferano poro aperto  
Saffron yellow open pore  
Jaune safran pores ouverts  
Safrangelb offenporigBianco poro aperto  
White open pore  
Blanc pores ouverts  
Weiss offenporigSabbia poro aperto  
Sand open pore  
Sablé pores ouverts  
Sandfarben offenporigCastagna poro aperto  
Chestnut open pore  
Châtaigne pores ouverts  
Kastanienbraun offenporigNero poro aperto  
Black open pore  
Noir pores ouverts  
Schwarz offenporig



Finishes

Pelle scamosciata  
Suede  
Suedine  
Wildleder



Sand 06



Sand 012



Grey 020



Grey 058



Grey 074

Ecopelle  
Eco leather  
Simili cuir  
Spaltleder

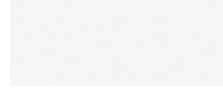

Bianco  
White  
Blanc  
Weiss

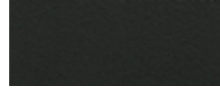

Nero  
Black  
Noir  
Schwarz

Cuoio / Pelle Sottomano  
Leather / Leather Sottomano  
Cuir / Cuir Sottomano  
Leder / Leder Sottomano

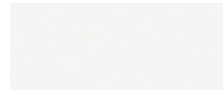

Bianco  
White  
Blanc  
Weiss

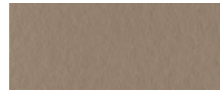

Tortora  
Taupe  
Taupe  
Beigegrau



Marrone  
Brown  
Marron  
Braun



Grigio  
Grey  
Gris  
Grau



Nero  
Black  
Noir  
Schwarz

Feltro WGS  
Felt WGS  
Feutre WGS  
Filz WGS



Lime



Brick



Natural



Stone

Velluto  
Velvet  
Velours  
Samt



Blue  
408



Mink  
518



Taupe  
537

Finishes

Tessuti  
Fabrics  
Tissus  
Stoffe  
100% view

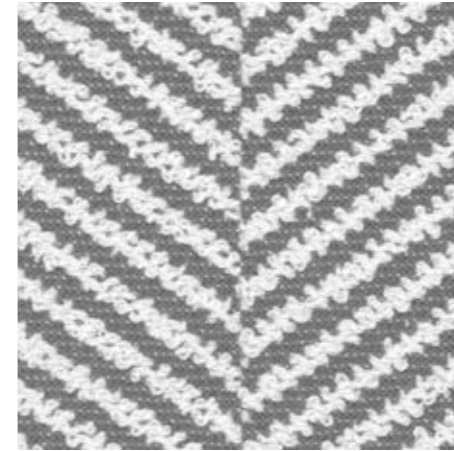

Clivia

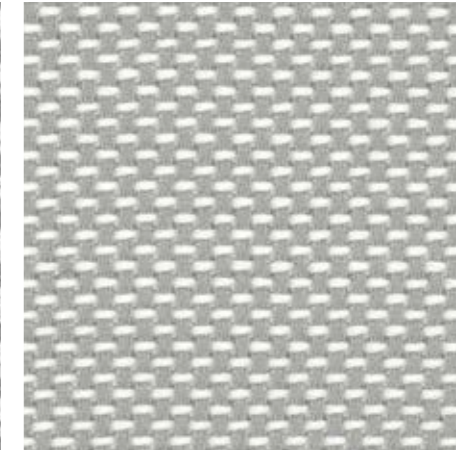

Corbezzolo



Narciso

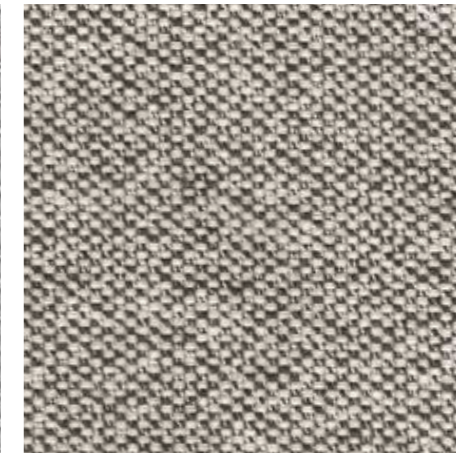

Reggio

**Credits**

Progetto grafico/  
Graphic design  
Studio CCRZ

Fotolito/Photoengraving  
Monogramma

Stampa/Printing  
Grafica Gioia

© Gallotti&Radice, 2014

Styling  
Patrizia Cantarella  
Giulia Zanotti

Fotografie/Photos  
Federico Cedrone  
Sergio Chimenti  
Matteo Imbriani

Si ringraziano/Thanks to  
Artemide  
Giacomelli Giardini  
Kasthall  
Kristiina Lassus  
Living Divani  
Oluce  
Penta  
Pineider

